

*Overview of the*  
**IP Multimedia System (IMS)**  
**- Principles, Architecture and Applications**

Prof. Dr. Thomas Magedanz

Technical University of Berlin / Fraunhofer FOKUS

(magedanz@fokus.fraunhofer.de)



**Abstract**

---

**This tutorial provides a technical overview of the architecture, components and protocols of the emerging 3GPP IP Multimedia Subsystem (IMS) / 3 GPP2 Multimedia Domain (MMD) which provides the technological basis for the provision of mobile multimedia services within 3G packet networks. This tutorial looks at the driving forces for the IMS architecture definition, introduces the key signalling and control protocols of all IP networks (i.e., SIP and Diameter) forming the basis for IMS component interactions, and explains the key IMS elements and their interactions. Special attention will be given to the IMS application server options, namely CAMEL, OSA/Parlay and SIP AS. The tutorial ends with an overview of the FOKUS IMS play ground ([www.fokus.fraunhofer.de/ims](http://www.fokus.fraunhofer.de/ims)).**

## The Presenter



### Prof. Dr. Thomas Magedanz

*Thomas Magedanz (PhD) is professor in the electrical engineering and computer sciences faculty at the Technical University of Berlin, Germany, leading the chair for next generation networks (Architektur der Vermittlungsknoten – AV).*

*In addition, he is director of the “3G beyond” division at the Fraunhofer Institute FOKUS, which also provides the national 3G beyond test and development centre in Germany.*

*He is senior member of the IEEE, editorial board member of several journals, and the author of more than 200 technical papers/articles. He is the author of two books on IN standards and IN evolution.*

*Based on his 18 years of experience in the teaching of complex IT and telecommunication technologies to different customer segments in an easy to digest way, Dr. Thomas Magedanz is a globally recognised technology coach. He regularly provides strategic and technology briefings for major operators and telecom vendors, as well he acts often as invited tutorial speaker at major telecom conferences and workshops around the world.*

3

## Contact



Fraunhofer  
Institute for Open  
Communication Systems

**Prof. Dr.-Ing. habil Thomas Magedanz**

*TUB Chair Next Generation Networks / Director FOKUS 3Gb Division*

✉ magedanz@fokus.fraunhofer.de

☎ +49 171 172 70 70

☎ +49 30 3463 7229

📍 Kaiserin Augusta-Allee 31  
14513 Berlin, Germany

4

## Overview

- **IMS Motivation**
- **IMS Overview**
- **IMS Key protocols (IETF SIP and Diameter)**
- **IMS Key components**
- **IMS Application Server options**
- **Sample IMS Multimedia Applications**
- **The IMS Playground @ FOKUS**
- **Summary**
- *References & Acronyms*

5

## Evolution towards Converged Networks

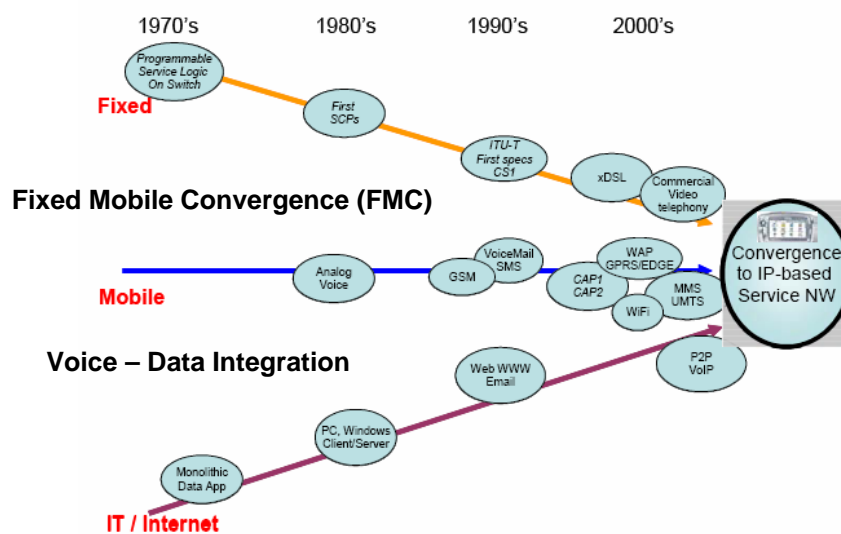

6

## VoIP Impact becomes visible in the Fixed World

*The traditional voice market is declining. Operators have to explore new market opportunities to fill the revenue gap!*

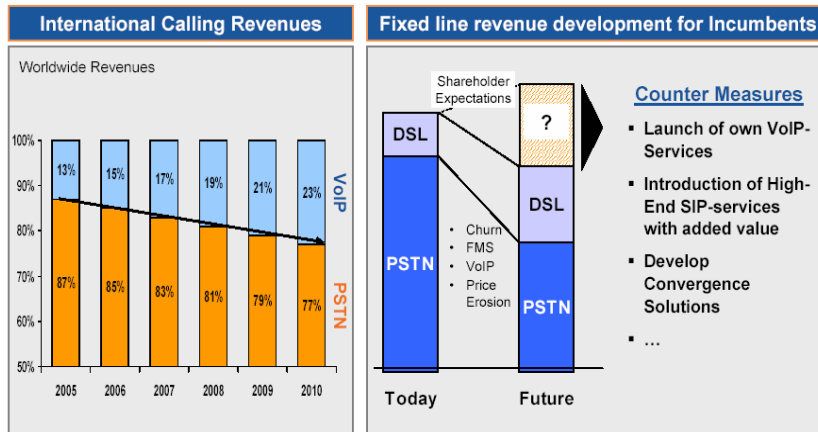

Source: Gartner 2005, Pyramid 2005, Detecon Research.

7

## War is not on networks, it is on services !

- Physical networks become transparent
- Market entry barriers for services vanish
- Value Chain splits horizontally
- Clear & present threats
  - losing VAS revenues
  - losing subscriber ownership
  - losing control over the Mobile Value Chain



8

## Action Points for Operators

- VoIP is putting significant voice revenues at risk!
  - Plain old VoIP services (= cheap) will become a commodity
- High-end „SIP-services“ (→ beyond VoIP services) allow for compensation
  - Use the opportunity to fill the increasing fixed voice revenue gap by new lifestyle orientated SIP-services
    - Rich VoIP services (including Multimedia Services)
    - Customized VoIP (lessons learned from the mobile world, i.e. ring tones, wall papers, etc.)
    - FMC VoIP services (enhancing VoIP to the mobile domain)
- FMC is the common battle field also addressed by Mobile NOs
- Do we have to distinguish between fixed and mobile operators in the mid – long run??
  - See France Telecom, Telecom Italia, Telefonica, watch out Deutsche Telekom
- Selected Value added Service architecture has to be bullet proof from both angles of view (Service Integration)
  - The IP Multimedia System represents this common ground!

9

## Pre-FMC = 3GPP Virtual Home Environment

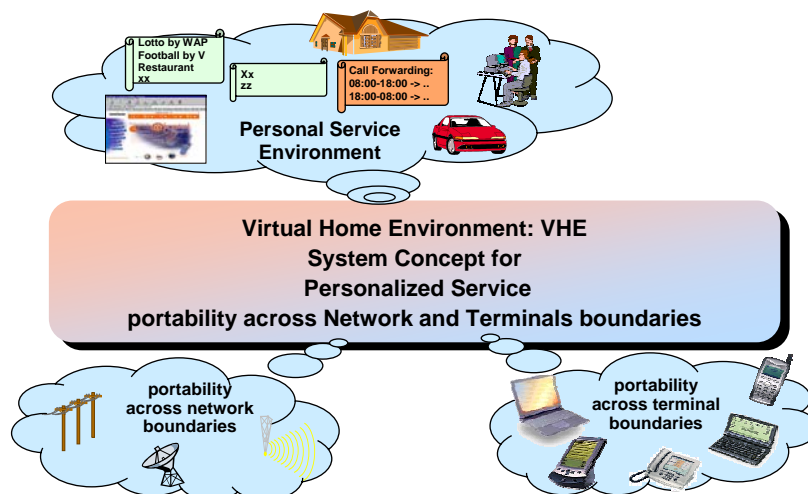

10

# Network Convergence

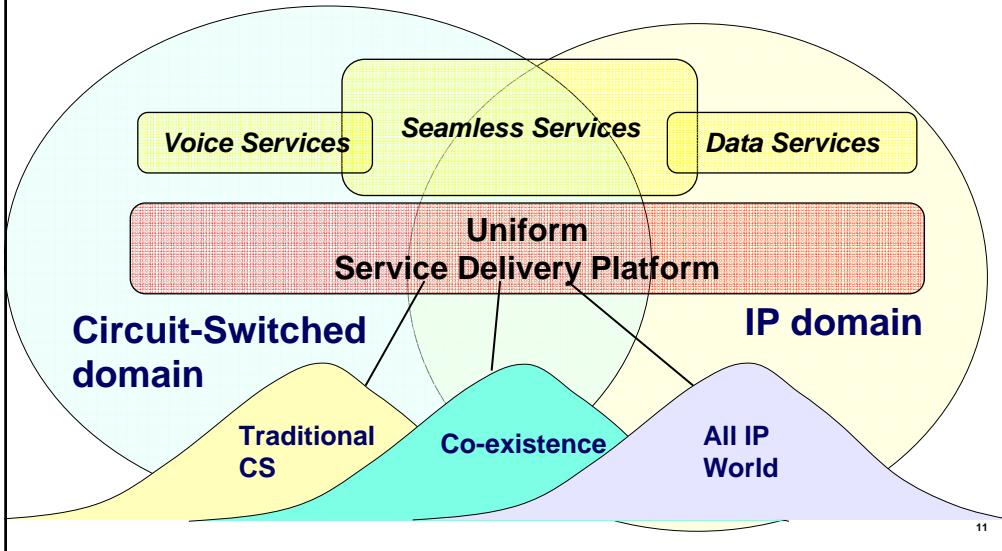

# Evolution of Service Delivery Platforms

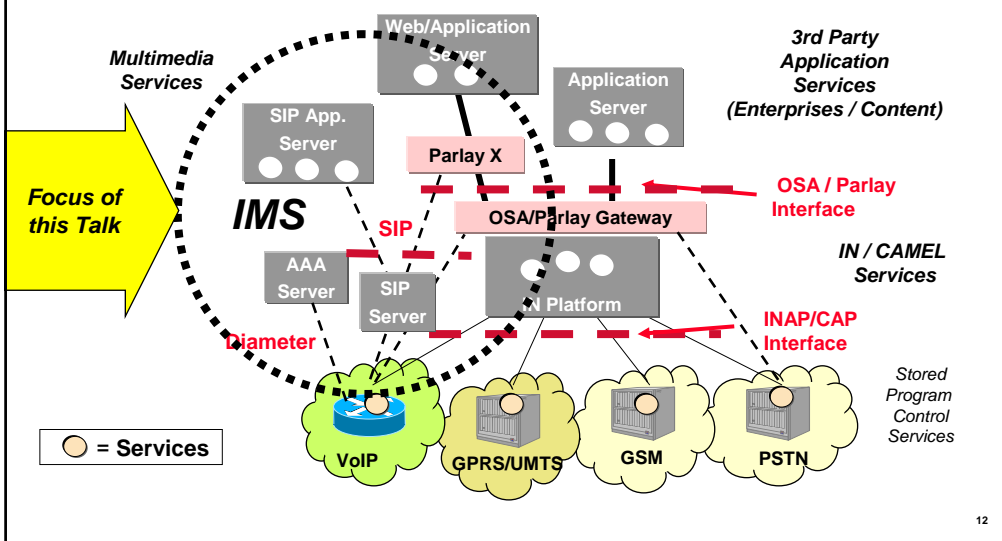

## Next Generation Network 3 Tier Architecture

- Enhanced services for the next generation network will be enabled by a tiered architecture where **“Application Servers”** will provide an independent service layer for the execution of enhanced services and content
- Session / Call Control based on advanced signaling protocols (i.e. SIP) is performed in Softswitches, or **“Session Servers”**
- Transport of signaling and content (incl. Voice) data will be done by **Routers** in the classical IP fashion. Dedicated nodes, i.e. **“Media Gateways”** and **“Media Servers”** are in charge for processing content data controlled by the Call Servers.

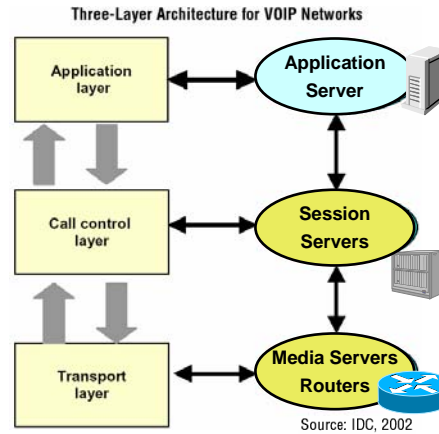

## Next Generation All IP Reference Architecture

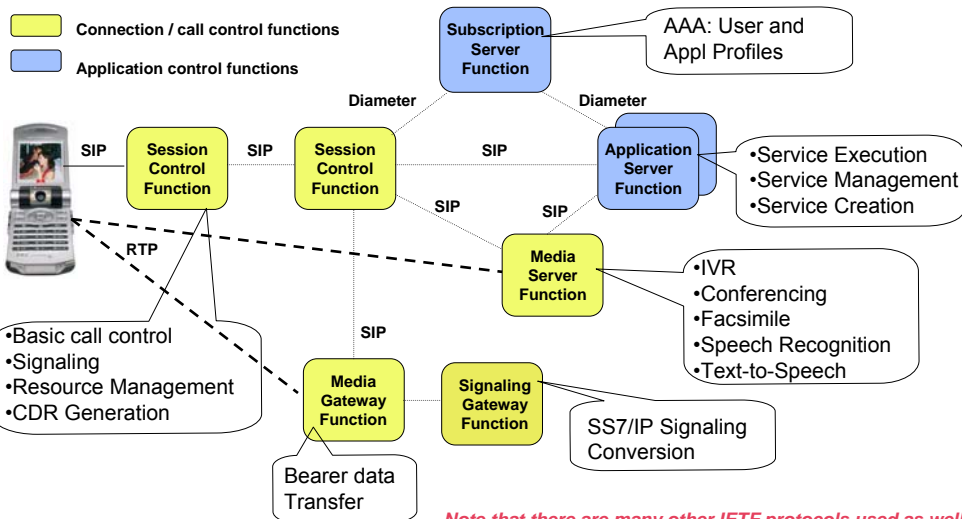

Note that there are many other IETF protocols used as well, e.g. SDP, Megaco, SCTP, RTCP, MSRP, XCAP, etc.

## Overview

---

- IMS Motivation
- **IMS Overview**
- IMS Key protocols (IETF SIP and Diameter)
- IMS Key components
- IMS Application Server options
- Sample IMS Multimedia Applications
- The IMS Playground @ FOKUS
- Summary
- Q&A and IMS Playground Demos
- *References & Acronyms*

15

## Motivation for IMS

---

- **The Hope: *Compete with classic internet services at weak points:***
  - *Provide QoS, security & charging and*
  - *enable real integrated multimedia services*
- **The Solution: the IP Multimedia System (IMS) as minimum common denominator**
- **Killer applications vs. universal service delivery platform**
  - Flexible service creation and service deployment is key
  - Openness to third party developers / providers (→ controlled enabling)
  - Integrated services – integration of existing and emerging services
  - Provide service uniform and seamless across different fixed and mobile networks
- **BUT: who will provide the „global“ IMS and owns the customer??**

16



## IMS Idea: Try to get Control of IP Services

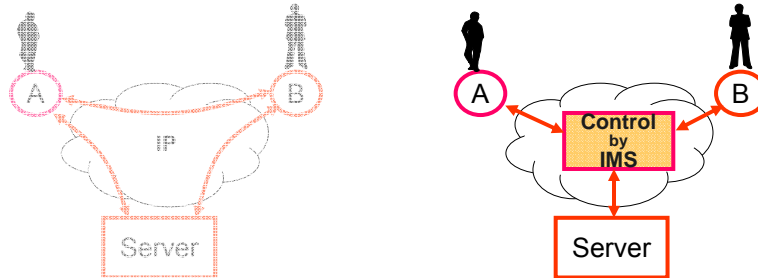

- The IP network allows free communication between endpoints
- IMS is able to control S(IP) services on an IP network

17

## IMS enabling Control of GPRS / IP services

### IMS Core Idea:

- Define an *IP Multimedia Overlay-Network* over GPRS (for Session control based on Internet protocols!)
- *Data (Media) transport* (as well as signaling transport) via GPRS
- Provide control (QoS, security, Charging) for IP services and person-to-person communication

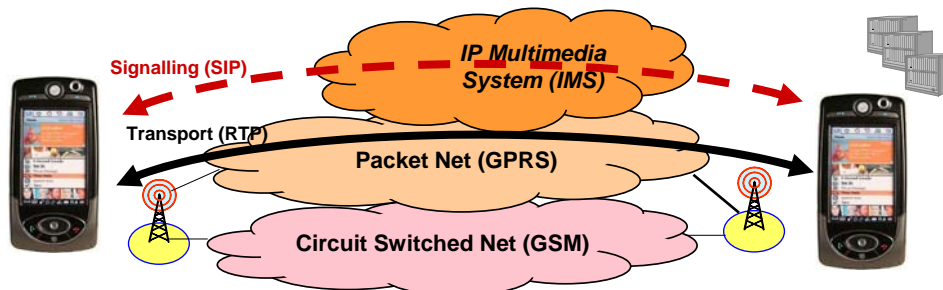

Note that IMS is for fixed networks applicable too <sup>18</sup>

## IMS Motivation – Flexible Service Provision

### Provision of service enablers

- Presence and Group server are considered key for the future
- Example: Push to Talk, but more generally community services

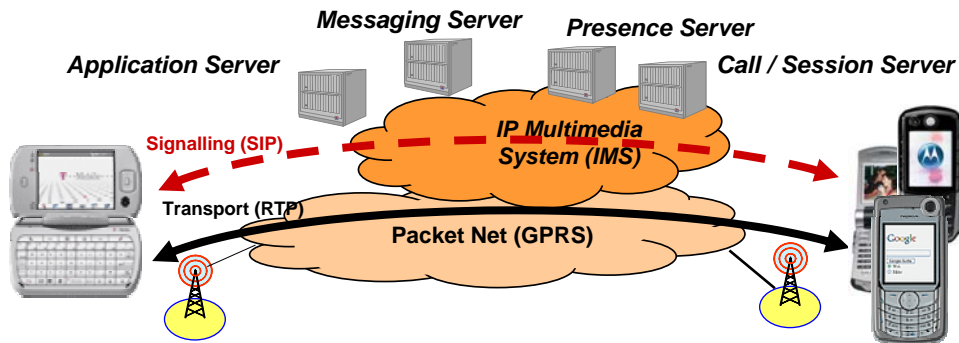

19

## IMS Architecture Principles

- IMS does NOT standardise specific services, but enablers
- BUT supports inherently multimedia over IP, VoIP, IM, presence (SIP)
- IMS enables the flexibility in providing Multimedia over IP services !!

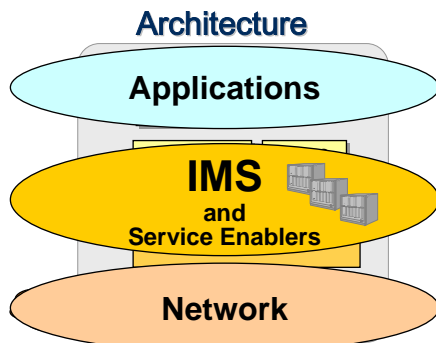

- Horizontal Architecture
- Build on existing IETF and telco SDP standards
- Use standard service enablers (e.g. Presence, GLMS/XDMS, etc.)
- Modular design and open interfaces

20

## 3GPP IP Multimedia Subsystem (IMS)

- The IMS was originally standardised by 3GPP as part of UMTS Release 5
  - Basic VoIP, IM, Presence support on top of GPRS
  - Adaptations to “real world” have been made in Release 6 (QoS, PoC support)
  - Release 7 will look at unified IMS for all IP access networks (DSL, WLAN, etc.)
- The IMS is based on the IP world protocols, namely
  - SIP (Session Initiation Protocol) for Session Control, and
  - Diameter for AAA (Authentication, Authorisation & Accounting)
  - plus many others, i.e. SDP, RTP, RTCP, MGCP, etc.
- Key components of the IMS architecture are
  - **Extended AAA Server (Home Subscriber System – as evolution of the HLR)**
  - **SIP servers / soft switches**
  - **Media Servers & Media Gateways**
  - **and Application Servers**

21

## IMS Layers: Transport, Session Control, Apps

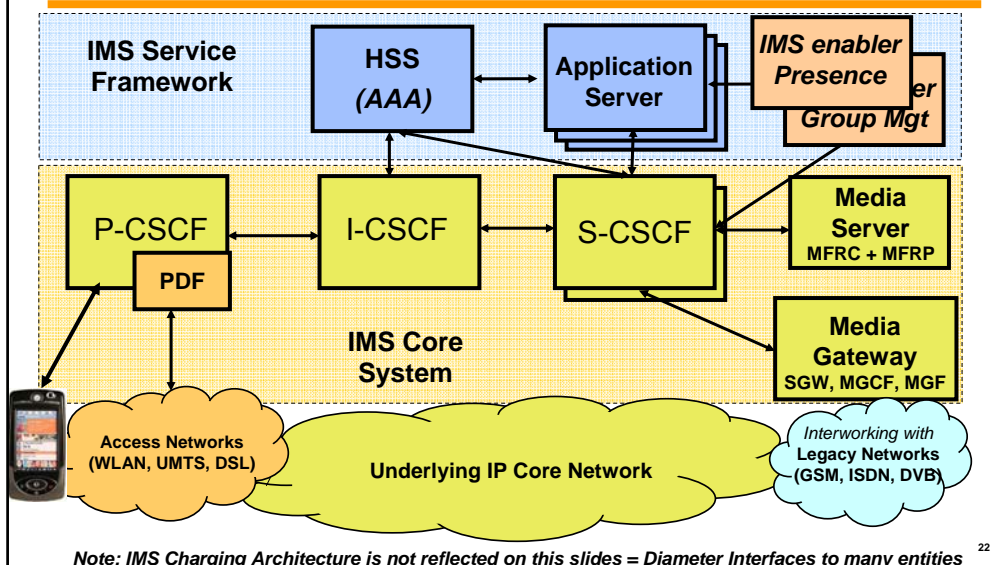

22

## IMS Major Components

---

- The IMS is an Overlay Session/Service Control architecture on top of the packet domain (GPRS, UMTS, WLAN, DSL) based on IP technologies and IETF protocols (e.g. SIP, Diameter):
  - **IMS Core**
    - **S-CSCF** (Serving Call Session Control Function) the IS anchor point in the home network
    - **I-CSCF** (Interrogating Call Session Control Function) providing topology hiding
    - **P-CSCF** (Proxy Call Session Control Function) Entrypoint into IMS world
    - **MS** (Media Server) – Media Server hosting special resources
    - **MGF** (Media Gateway) for Interworking with legacy networks
    - **PDF** (Policy Decision Function) for QoS Control using Policies (COPS)
  - **IMS Application Layer**
    - **HSS** (Home Subscriber System) for maintaining subscriber and AS profiles
    - **AS** (Application Server Function) for hosting applications
    - **IMS enablers** (e.g. Presence, Group Mgt.) are specific ASs with generic functions
  - And the **IMS end system (IMS Client)** plays an important role real multimedia / IMS services

23

## Overview

---

- **IMS Motivation**
- **IMS Overview**
- **IMS Key protocols (IETF SIP and Diameter)**
- **IMS Key components**
- **IMS Application Server options**
- **Sample IMS Multimedia Applications**
- **The IMS Playground @ FOKUS**
- **Summary**
- **Q&A and IMS Playground Demos**
- *References & Acronyms*

24

## IMS Layers: Transport, Session Control, Apps

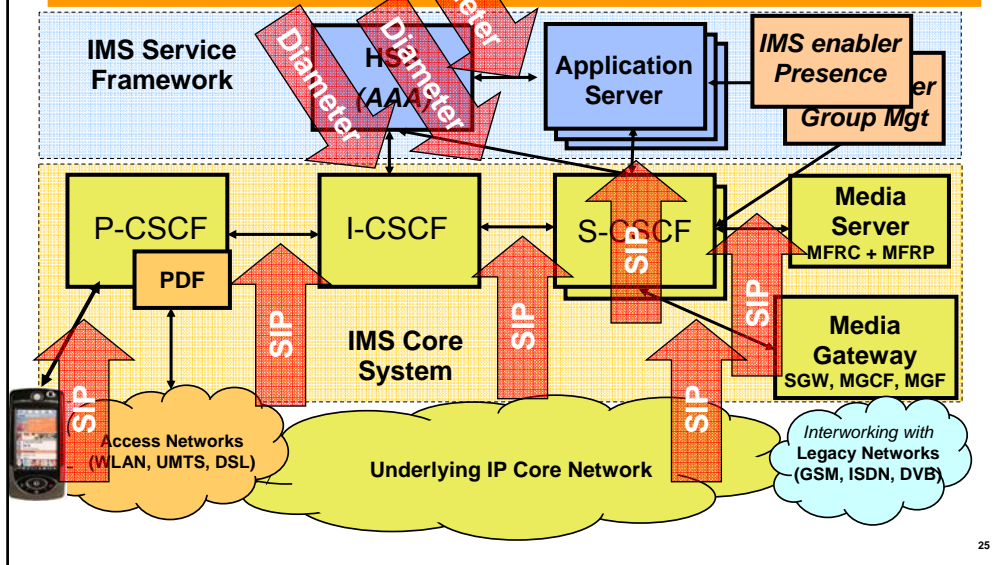

25

## IETF Session Initiation Protocol (SIP)

- SIP is THE VoIP protocol enabling to initiate, terminate, and modify service sessions
  - Multimedia(!) sessions (*not just voice-centric!*)
  - Point-to-point and multiparty
- Support for
  - registration and modification of multiple user location information
  - caller and callee authentication / call authorization
  - privacy for call signaling and media streams
  - media path with ensured QoS
- Flexible service creation
  - support through SIP servers (located inside and outside the network)
- Extensible protocol to cover new communication aspects
  - Such as for presence and instant messaging
- Used together with Session Description Protocol
  - No Bearer support (RTP and RTCP are used for that) !!
- Developed and maintained by IETF (MMUSIC and SIP WGs)
- RFC 3261: [www.ietf.org/html.charters/sip-charter.html](http://www.ietf.org/html.charters/sip-charter.html)

26

## Local SIP Architecture

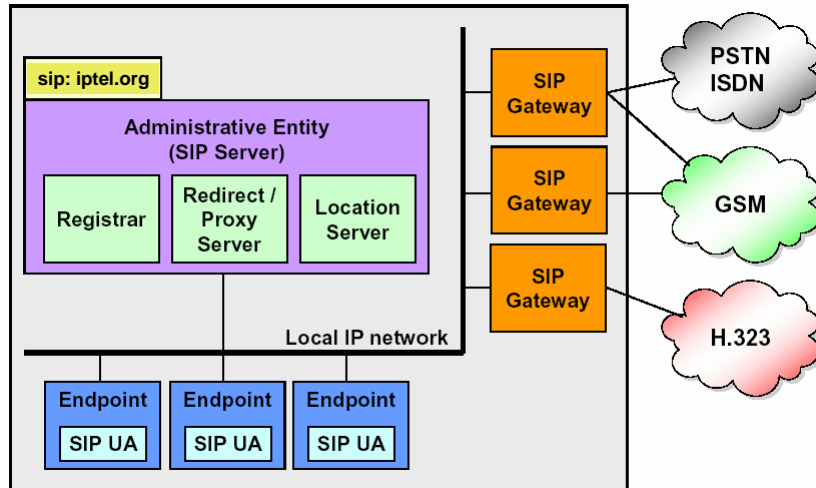

27

## Basic SIP Requests

- **REGISTER:** allows Clients to register their current location (one or more addresses)
- **INVITE:** is used to initiate a call.
- **ACK:** is sent by a client to confirm that it has received a final response from a server, such as 200 OK.
- **BYE:** is sent either by the calling agent or by the caller agent to abort a call
- **CANCEL:** can be sent to abort a request that was sent previously as long as the server has not yet sent a final response.
- **OPTIONS:** allows clients to learn a servers capabilities. The server will send back a list of the methods it supports.

28

## Additional SIP Requests

- **SUBSCRIBE:** starts or stops session or user supervision (event monitoring)
- **NOTIFY:** informs subscribed entity about occurred events
- **PUBLISH:** enables an entity to modify presence information
- **MESSAGE:** allows to send an instant message
- **REFER:** informs an recipient to contact a dedicated SIP user (e.g. MWI)
- **PRACK:** PRovisional ACKnowledgement
- **UPDATE:** Change of media (SDP) during session setup
- **INFO:** Exchange of any application layer information (e.g. DTMF)

29

## SIP Responses

### SIP Responses defined as (HTTP-style):

- **SIP-Version SP Status-Code SP Reason-Phrase**
- **CRLF** (SP=Space, CRLF=Carriage Return and Line Feed)
- **Example:** SIP/2.0 404 Not Found
- **First digit gives Class of response:**

	Description	Examples
1xx	Informational – Request received, continuing to process request.	180 Ringing 181 Call is Being Forwarded
2xx	Success – Action was successfully received, understood and accepted.	200 OK
3xx	Redirection – Further action needs to be taken in order to complete the request.	300 Multiple Choices 302 Moved Temporarily
4xx	Client Error – Request contains bad syntax or cannot be fulfilled at this server.	401 Unauthorized 408 Request Timeout
5xx	Server Error – Server failed to fulfill an apparently valid request.	503 Service Unavailable 505 Version Not Supported
6xx	Global Failure – Request is invalid at any server.	600 Busy Everywhere 603 Decline

30

## SIP Message Body = SDP

- Message body can be any protocol
- However, in most implementations it is SDP (Session Discription Protocol)
  - SDP - Session Description Protocol
  - RFC 2327 4/98 by Handley and Jacobson
    - <http://www.ietf.org/rfc/rfc2327.txt>
  - Used to specify info about a multi-media session.
  - SDP fields have a required order
  - For RTP - Real Time Protocol Sessions:
    - RTP Audio/Video Profile (RTP/AVP) payload descriptions are often used

31

## A SIP Signalling Scenario

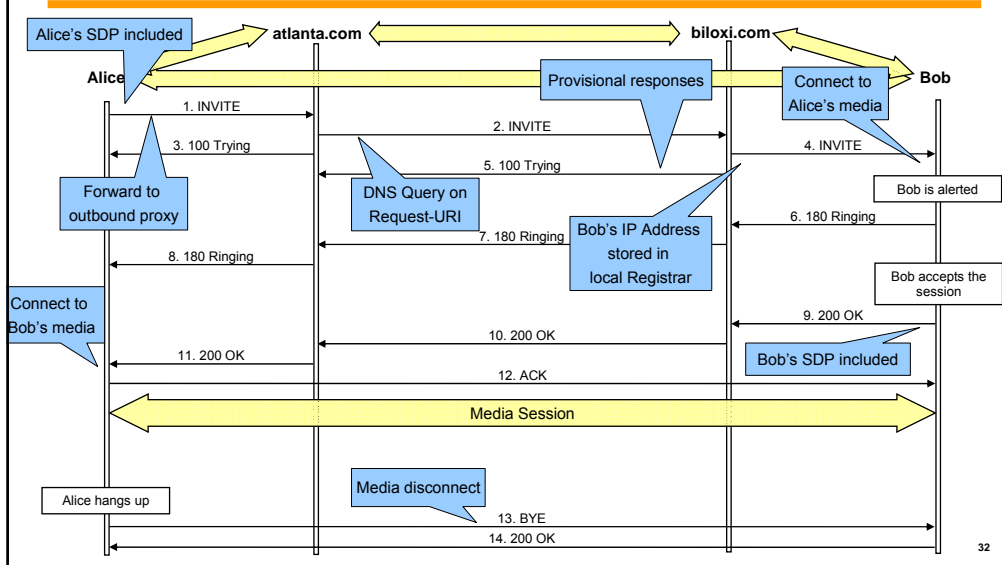

32



## SIP Server Operation Models

### Redirect Server

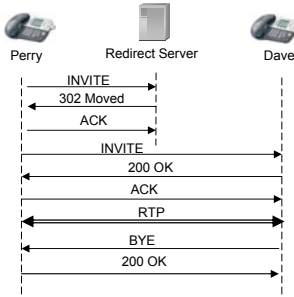

**Transaction-oriented,  
Routing, Translation  
Services**

### Proxy Server

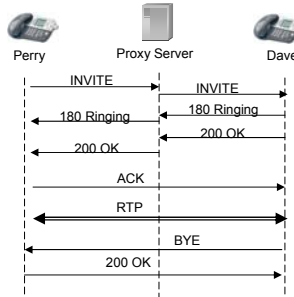

**Call Management,  
Event-driven Services**

### B2BUA Server

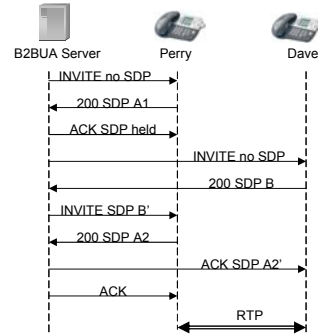

**Call (Leg) Creation and  
Manipulation Services**

33

## Application Evolution - The SIP Influence

SIP as an open communications protocol is considered a key enabler for real-time converged communications and the development of interactive services.

### SIP session and SIP-enabled services

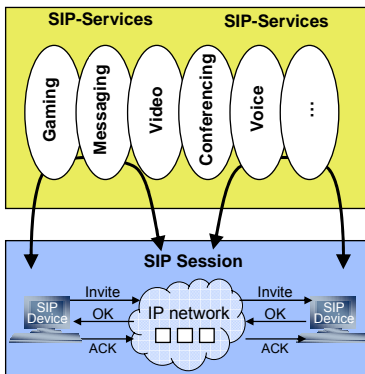

### basic SIP functionality

- User Presence/Availability  
Establishment of user presence and availability (buddy-list functionality of IM)
- User Location&Mobility  
Establishment of current IP address. Support of personal and terminal mobility
- Multimedia Support  
Supports voice, e-mail, IM, video and any other form of application with session characteristics
- Call Setup & Processing  
Establishment and management of communication parameters (e.g. codec, timeframe, ...)

### SIP-enabled services

- Unified Messaging
- Chat
- Multimedia Conferencing
- Push-to-talk
- Online Games
- Distributed Virtual Reality Systems
- Push Services
- Interactive Entertainment
- IP-PBX, IVR

34

## ***IETF Diameter Protocol for AAA***

---

- New IETF protocol for Authentication, Authorization and Accounting (AAA) services
  - Internet Draft “DIAMETER Framework” (1998) by IETF AAA WG
  - RFC 3588 DIAMETER Base Protocol (2003)
- Developed based on the requirements of 3G mobile network operators, ISPs and other IETF groups since 2001
- Used in the 3GPP IMS for HSS access
- Extends the RADIUS functionalities:
  - Introduction of Agent roles (proxy, relay, redirect & translation agents)
  - Enables server-initiated messages
  - Uses UDP, TCP and new SCTP protocol for reliable message transport
  - Is backward compatible to RADIUS infrastructures by using translation agents
  - Integrates vendor specific commands and AVPs
  - Explicit modular structure = is extendible

35

## ***IETF AAA Work Group***

---

- **GOAL**
  - Develop the Diameter Standard based on the requirements of other IETF WGs (NASREQ, MOBILE IP, ROAMOPS), 3GPP and 3GPP2
- **WG defines: message format, error messages, accounting support, IPv6 support, backward compatibility with RADIUS, data model, security framework, Management Information Base (MIB)**
- **Achievements:**
  - RFC 3588 Diameter Base Protocol
  - Several other AAA RFCs
  - multiple Diameter application drafts
- **Web link: [www.ietf.org/html.charters/aaa-charter.html](http://www.ietf.org/html.charters/aaa-charter.html)**

36

## Diameter Base Protocol

- RFC 3588 approved in September 2003 (NEW)
- provides an AAA framework for applications
- works for local AAA and in roaming situations
- The RFC defines
  - agent roles
  - sessions and connections
  - header, AVP and data formats
  - Command codes, AVPs, Result codes and Diameter application IDs
  - the state machines used within Diameter
  - error handling, failover algorithms
  - basic accounting procedures
- Web link: <ftp://ftp.rfc-editor.org/in-notes/rfc3588.txt>

37

## Diameter Extensions of the Base Protocol

- Diameter is designed in terms of a Base Protocol (RFC 3588) and an extensible set of applications

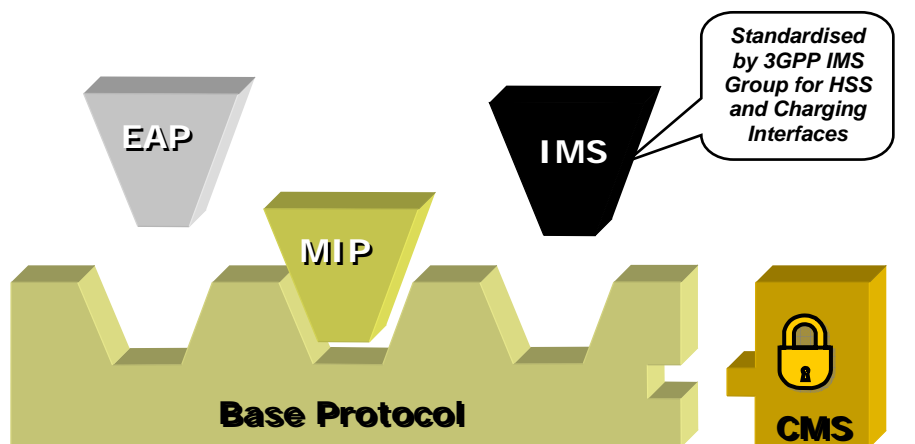

38

## Overview

---

- IMS Motivation
- IMS Overview
- IMS Key protocols (IETF SIP and Diameter)
- **IMS Key components**
- IMS Application Server options
- Sample IMS Multimedia Applications
- The IMS Playground @ FOKUS
- Summary
- Q&A and IMS Playground Demos
- *References & Acronyms*

39

## IMS 3GPP Evolution

---

- IMS brainstorming started in Release 4, without real specs.
- IMS Release 5 is the first complete specification of IMS finished in 2003 (but based on some unrealistic assumptions;- ( )
- Key features of IMS Release 5:
  - **IMS Architecture:** IMS Architecture, network entities, reference points (interfaces) between the network entities.
  - **User Identities:** Public/Private User Identity, usage of the SIP-URI and TEL-URI, ISIM, the use of the USIM instead of the ISIM.
  - **IMS Session Control:** IMS Registration, IMS Session Routing, Session-Modification and Teardown, SIP Signaling Compression.
  - **IMS Service Control:** invocation/control of IMS Application Servers based on Filter Criteria in the CSCF. IM-SSF and there-use of CAMEL Services. Interconnect with the OSA-GW and the use of OSA services.
  - **QoS Mechanisms:** QoS Preconditions, QoS/Media Authorization based on the PDF.
  - **Security Mechanisms:** IMS User Authentication, Message Integrity Protection, IMS Network Domain Security.

40

## IMS 3GPP Release 6

- Release 6 adapted IMS to the real world (i.e. lack of IMS SIM cards, IPv6 deployment, competing PoC standards), etc.) and was finished end of 2005
- Key Features defined in Rel-6 IMS:
  - **IMS Interworking:** IMS Interworking to the CS-Domain (more details for CS and PSTN), Interworking with SIP Clients in the Internet (IPv4/v6 Interworking), WLAN access to the IMS (not completed)
  - **IMS Session Control:** multiple registrations, routing of group identities.
  - **Security Mechanisms:** confidentiality protection of SIP messages, use of public key infrastructure, Ut-interface security, early IMS security
  - **IMS Services:** Presence, Instant Messaging, Conferencing, group management.

41

## IMS Architecture

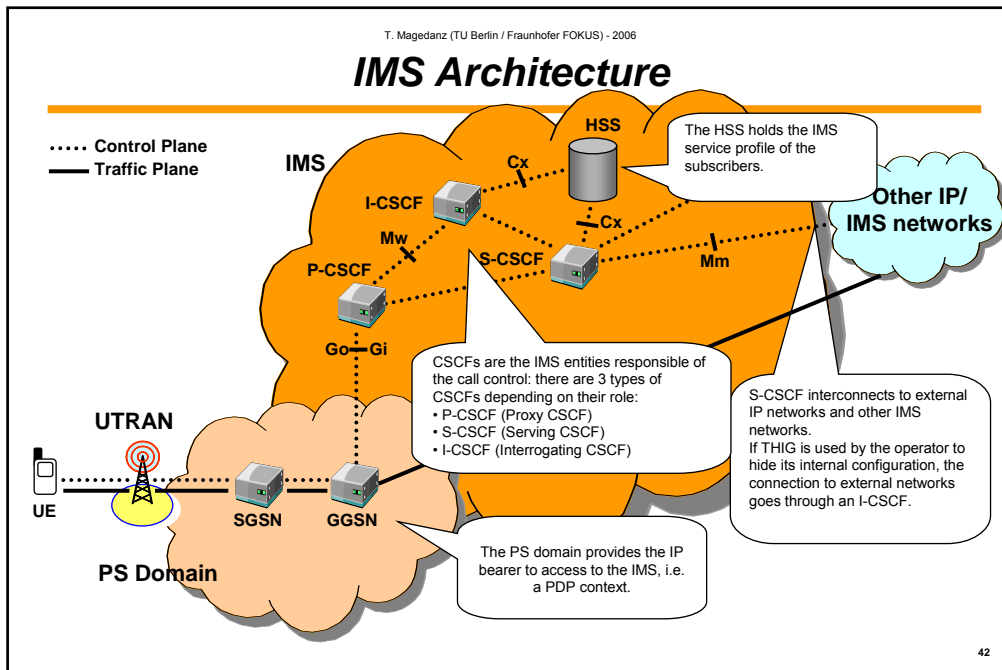

42

## IMS Architecture (cont.)

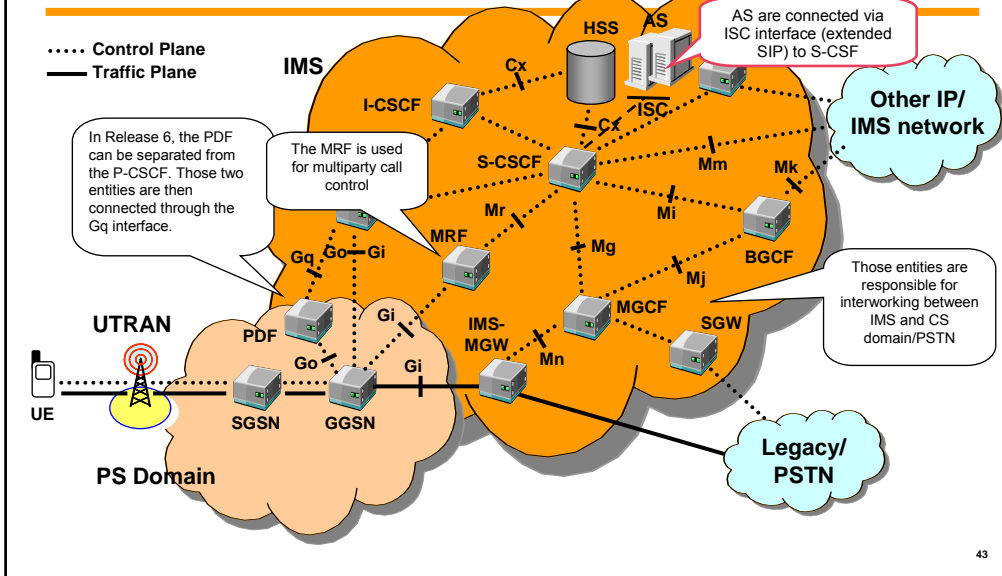

## IMS-Session: Home Networks are always involved

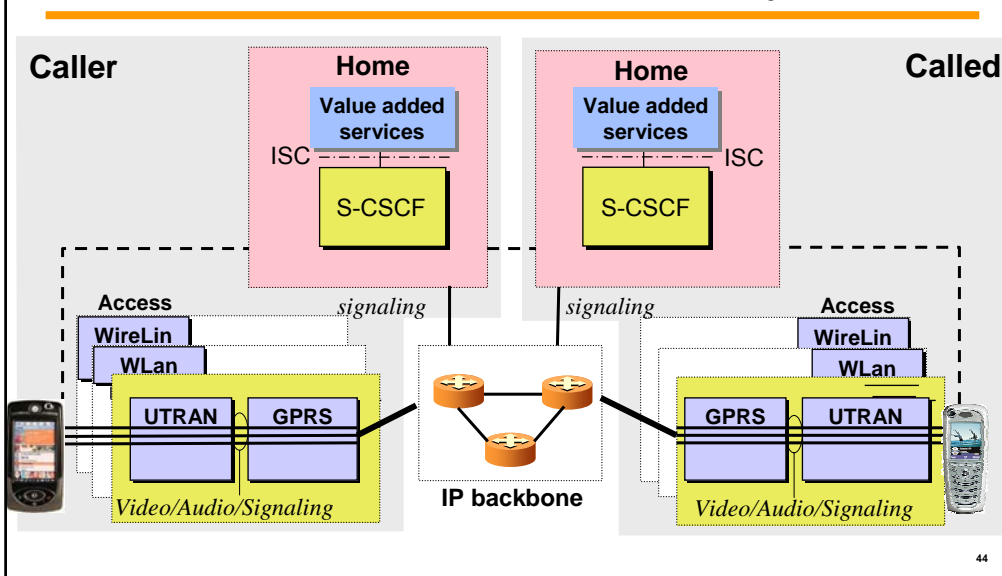

## IMS: Separation of Signaling and Media transport

### mobile to mobile session

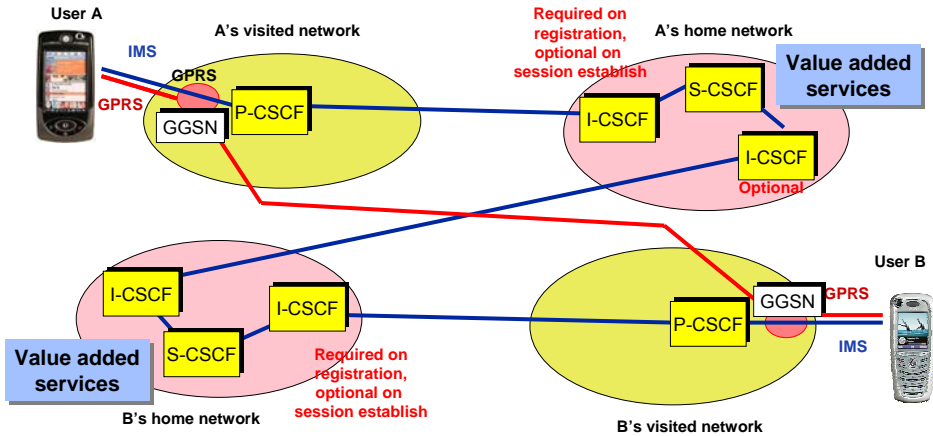

45

## IMS User Identity Concept

Each IMS User has at least one private and one or more public User Identities

- **IMS Private User Identity:**
  - belongs to the IMS operator
  - is not used for routing of SIP messages
  - uses the format defined in RFC 2486
    - Example: user-X@ims.operator.com
  - is stored on the ISIM card (in the mobile phone) and in the HSS (in the IMS User Profile)
- **IMS Public User Identity:**
  - is public and may be subject to Number Portability
  - is used for routing of SIP messages
  - may use the SIP-URI format defined in RFC 3261 and/or the TEL-URI format defined in RFC 2806
    - Example SIP-URI: "sip:user-X@company-X.com"
    - Example TEL-URI: "tel:+491231234567"
  - At least one Public User Identity is stored on the ISIM card
  - All Public User Identities are stored in the HSS

46

## **Public Service Identities (PSIs)**

---

- Similar to public user identities, but allocated to services (ASs) rather than users
- Used to identify specific applications Servers (enablers), such as presence or group list servers
- Typically take the form of a SIP URI or TEL URI
  - sip: songdownload@t-online.de, presence@t-online.de, chat@partner.de
  - tel: +49-900-123-456
- PSIs are treated as PUIs, i.e. easy routing of SIP requests to ASs (as end user systems → also called „service routing“)
- Public Service Identities are not authenticated
  - i.e., there is no corresponding private user (service) identity

47

## **How the IMS differs from RFC 3261 SIP Servers**

---

- The IMS was designed based on RFC 3261 (the CSCF is basically also a SIP Server) ... but includes much more!
- Additional functions were added to the IMS:
  - Subscriber Management, Service Control, Single-Sign-On User Authentication,
  - QoS/Media Authorization, Charging and Charging Correlation,
  - Resource Management, Interworking, Compression, Conferencing Support, Regulatory
  - Service Support, etc.
- Most of the IMS functions were taken from the IETF or were afterwards defined in the IETF:
  - Update (RFC331), Preconditions (RFC3312), PRACK (RFC3262), Offer/Answer (RFC 3264), QoS/Media Authorization (RFC 3313), Event Notification (RFC 3265),
  - Tel-URIs (RFC 2806), 3GPP P-Headers (RFC3455), Service-Route (RFC3608),
  - Asserted ID (RFC3325), DNS-Support (RFC 3263), SigComp (RFC3320, RFC3485, RFC 3486),
  - ENUM (RFC2916, RFC2915), SIP Refer (RFC3515), Digest AKA (RFC 3310),
  - Path-Header (RFC 3327), Security-Mechanism-Agreement (RFC3329), etc.
- A Service Infrastructure Network could also be built up starting with a standard RFC 3261 SIP Server.
- When extended to support the same Support Functions, then such a solution becomes similar to the IMS.

48



## User Registration and Authentication

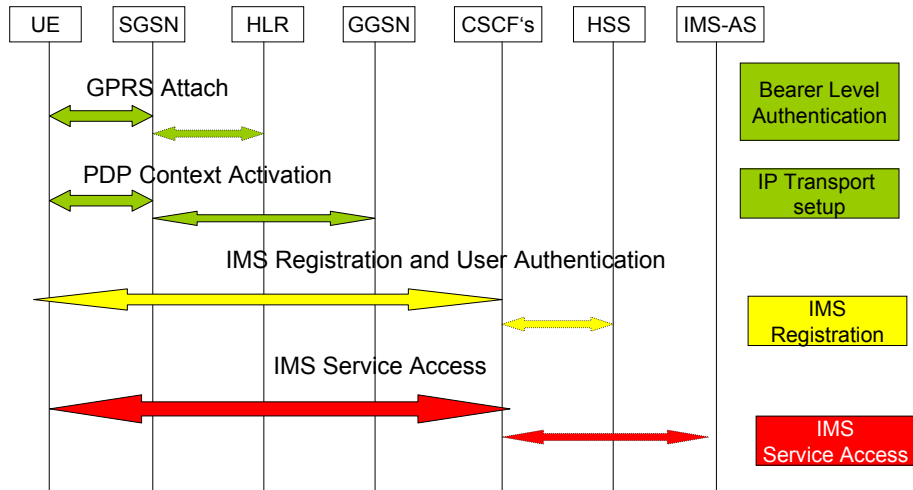

49

T. Magedanz (TU Berlin / Fraunhofer FOKUS) - 2006

## IMS Session Setup & Control

- This happens after User Registration (and Authentication!)
- Why do we need the IMS Session Setup ?
  1. Capability Negotiation (e.g. negotiation of session components, codecs, port numbers, addresses, etc.)
  2. Network Resource Reservation and the support of QoS Preconditions
- Additional Functions performed by the IMS during the IMS Session Setup:
  - Routing to the Terminating IMS (= the IMS of the B-Party)
  - Routing / Breakout to the PSTN / CS-Domain when the B-Party is not in the IMS, but in the PSTN / CS-Domain
  - Service Control / Invocation of Application Servers to trigger the execution of Originating- and/or Terminating IMS Services
  - Integrity/Confidentiality Protection of SIP Messages
  - QoS/Media Authorization
  - SIP Signaling Compression

50

## IMS QoS Support

- The actual Network QoS for IMS services is provided by the Access Network (e.g. based on UMTS QoS) and the IMS network infrastructure (e.g. based on Diff-Serv support in routers and switches).
- The IMS provides a correlation and control mechanism based on the use of the Policy-Decision-Function (PDF).
- Key functions of the PDF:
  - acts as Policy Decision Point (PDP):
    - the GGSN is the corresponding Policy Enforcement Point (PEP).
  - authorizes and controls the resource usage for each bearer (e.g. GPRS/UMTS PDP-Context):
    - this prevents the misuse of Network QoS and the theft of service.
    - this allows to limit the resource consumption.
  - exchanges Charging Correlation Identifiers with the GGSN (ICID, GPRS Charging ID):
    - this allows the correlation of charging information generated in the PS-Domain (SGSN, GGSN) and in the IMS (e.g. CSCF, AS).

51

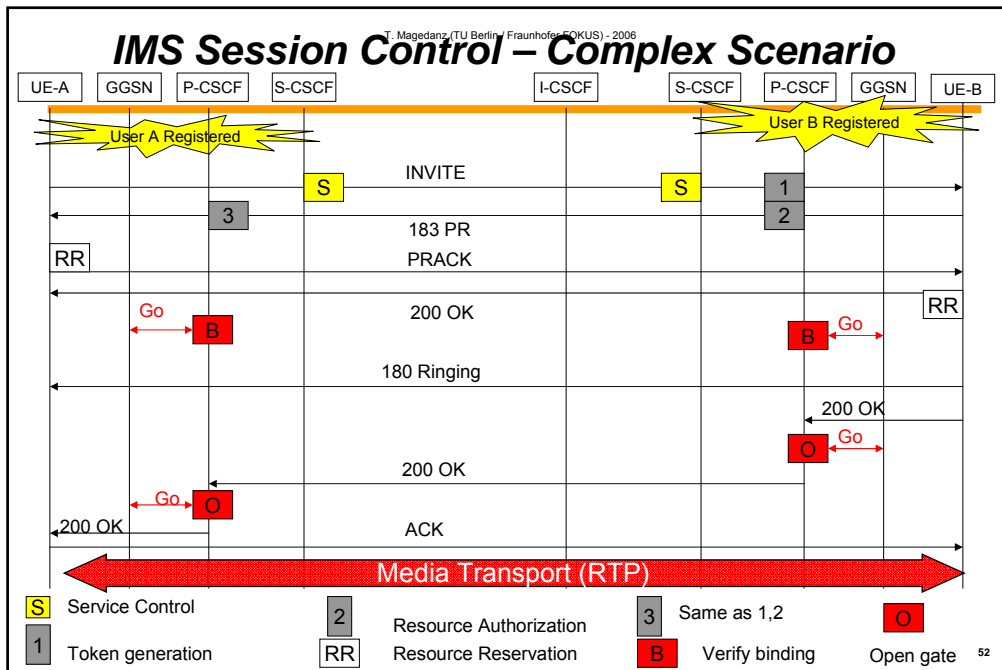

## IMS Session Binding and QoS Bearer Control

- The Media/QoS Authorisation is performed on a per-session basis using the Go-interface and an IMS Authorisation Token used for the IMS Session Binding.
  - enables the IMS to: authorise/open/close/modify the IMS Bearer Path (e.g. for Voice/Video Traffic).
- IMS Application Servers are not involved in the IMS Session Binding Procedure.

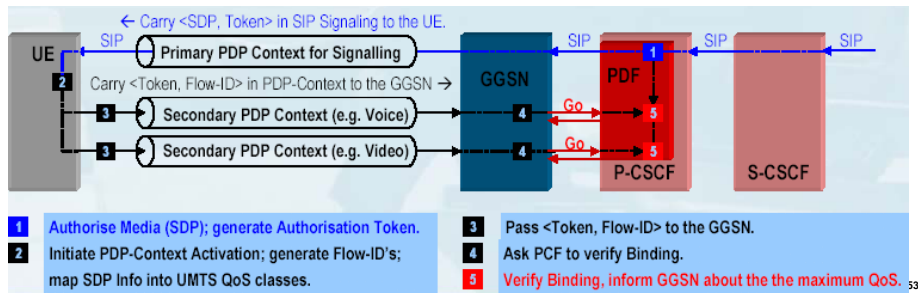

## Session Initiation - 1

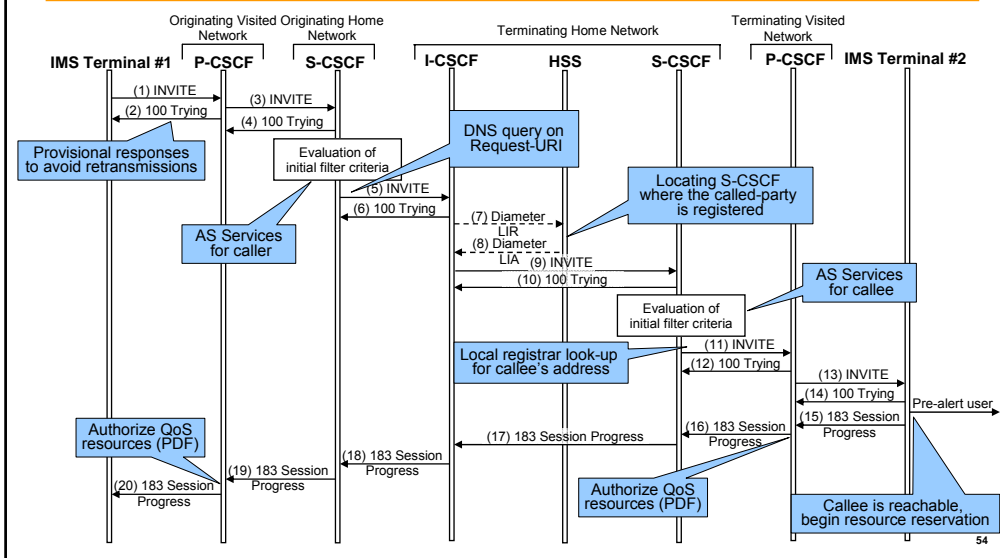

## Session Initiation - 2

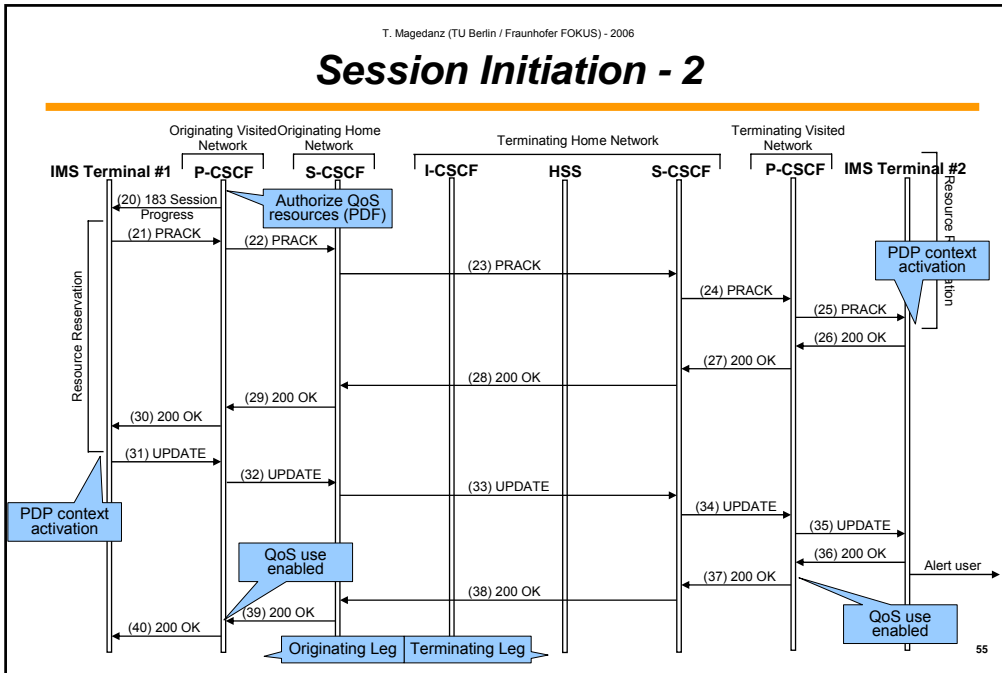

## Session Initiation - 3

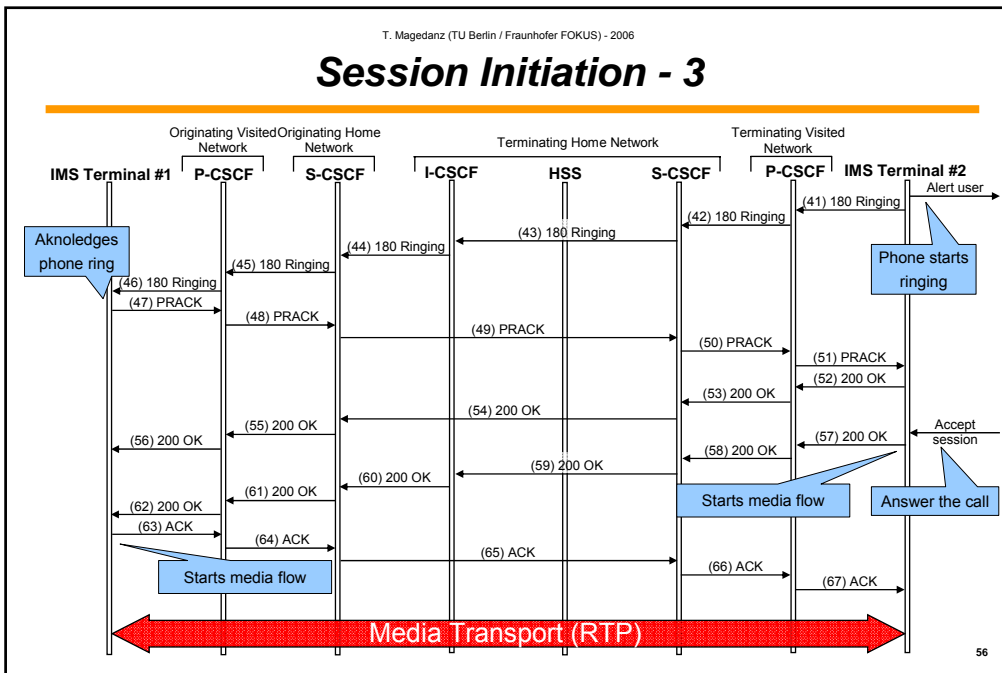

## IMS charging and operator strategy

### Pricing based on transport

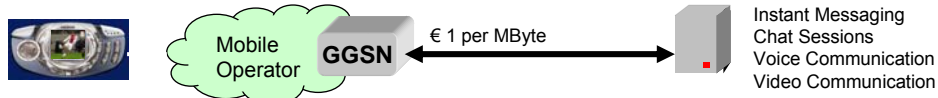

### Pricing based on services

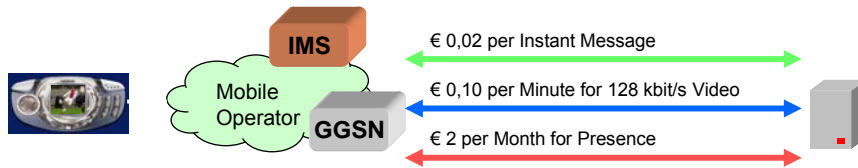

*IMS charging provides operators to be more than "bit pipe" provider*

57

## IMS Charging Architecture

- The IMS is designed to satisfy multiple business models
- The IMS charging model provides high flexibility
- Examples:
  - Charging based on time, bandwidth (AMR vs. G711), media stream (audio, video), services (e.g. instant message, content, etc.), events (presence, warnings etc.)
- IMS supports two charging architectures
  - Offline Charging (e.g. for post paid contracts)
  - Online Charging (e.g. for prepaid contracts)
- Main protocol used for charging is Diameter
  - With addition of a few AVPs in the Diameter base protocol
  - With the addition of a credit control application to support offline charging (Rf interface)

58

## IMS Charging Architecture

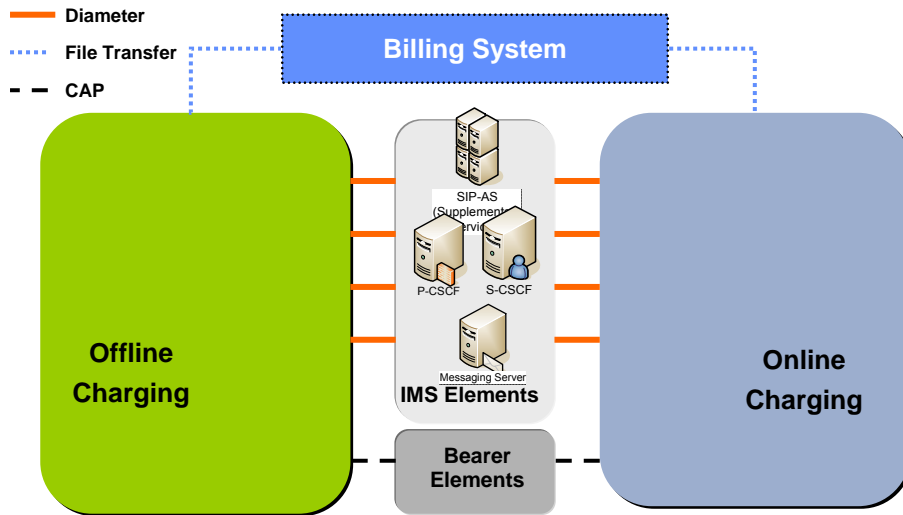

59

## Offline Accounting Principles

- **Charging Trigger Function (CTF)**
  - watches for accountable events
  - sends them
- **Charging Data Function (CDF)**
  - construct CDRs from events received via Rf reference point
  - events may be of several types
- **Charging Gateway Function (CGF)**
  - collect, validate and (persistently) store CDRs (in files)
  - forward batch files to Billing domain

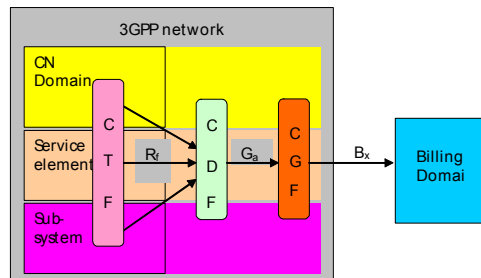

60

## Online Accounting Principles

- **Charging Trigger Function**
  - Sends events for authorization to OCF
  - Must delay resource usage until permission is granted
  - Must support quota supervision during resource usage/consumption
- **Online Charging Function has 2 modules**
  - **Session based Charging**
    - charges network / user sessions (e.g. voice calls, GPRS PDP contexts or IMS sessions)
  - **Event based Charging**
    - event-based online charging (also referred to as "content charging") in conjunction with any application server (e.g. SIP) or service NE
- **Account Balance Management Function**
- **Rating function (for data volume, session time & service events)**

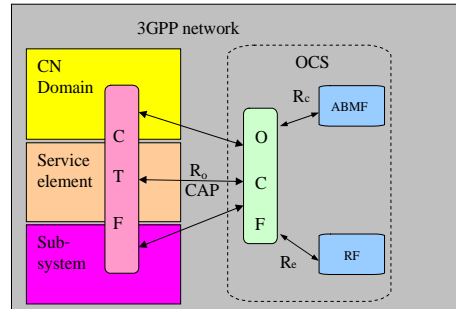

61

## IMS Security

- **Two security solutions are proposed**
- **Full IMS security**
  - Standardized in Release 5 and 6 with full features
  - Defines security in the network and the terminals
  - Requires ISIM and rich features in the terminal, P-CSCF and S-CSCF
- **Early IMS Security**
  - Standardised in Release 6
  - Idea: Reuse GPRS authentication (and IP address) for IMS authentication
  - Developed for early IMS deployment without existence of all security enablers
  - Not stringent as the full IMS security solution
  - Intended to have minimal impact on existing terminals
  - Offers less security but good enough for early deployment

62

## Complete IMS Security Solution

- Divided into:
  - Network Domain Security (already existing for GPRS)
  - Access Domain Security (linked to SIP and CSCFs / HSS)
- SIP Security is provided on a hop-by-hop fashion
  - End-to-end security is not supported !
- Terminals accept a UICC (Universal Intergraded Circuit Card) that contains an ISIM (IMS Subscriber Identity Module) application
- The ISIM stores identities (public, private), home domain, and long term security keys
- The S-CSCF authenticates the user at SIP registration time
- The security mechanism is negotiated (but only IPSec is supported so far)
- Authentication scheme based on the UMTS AKA (Authentication and Key Agreement) called IMS AKA
- Delegate identity enforcement to the P-CSCF
- P-CSCF and UE establish an IPSec connection for integrity protection (Release 5 onwards) and confidentiality (Release 6 onwards)

63

## Complete IMS Security

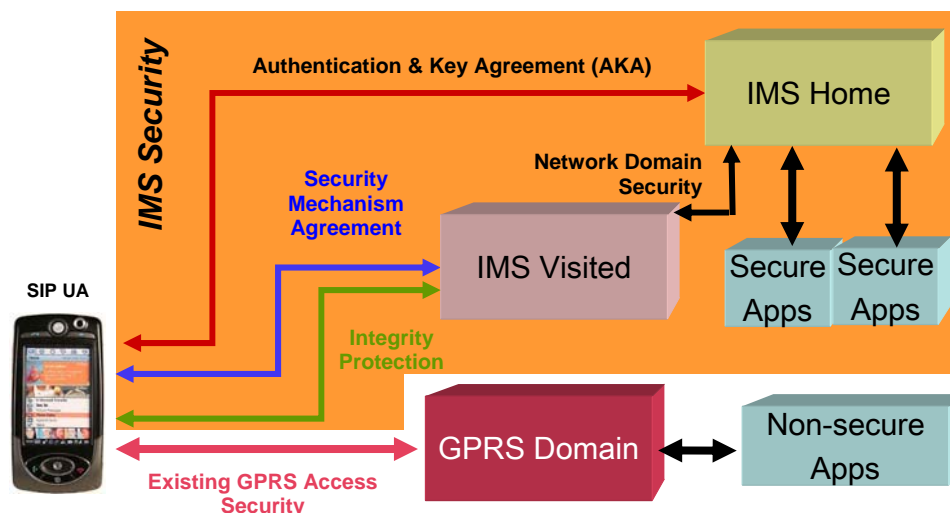

64



## Overview

- IMS Motivation
- IMS Overview
- IMS Key protocols (IETF SIP and Diameter)
- IMS Key components
- **IMS Application Server options**
- Sample IMS Multimedia Applications
- The IMS Playground @ FOKUS
- Summary
- Q&A and IMS Playground Demos
- *References & Acronyms*

65

## IMS Service Invocation and Interaction

- Service triggers on initial SIP requests at SIP Proxy (S-CSCF)
- Service Proxy proxies request to corresponding AS based on triggers and Filters
- AS acts as user agents, proxy server, 3PCC or B2BUA
- AS may Record-Route SIP request to stay in signalling path
- Service Proxy maintains the states between dialogs sent to/from applications

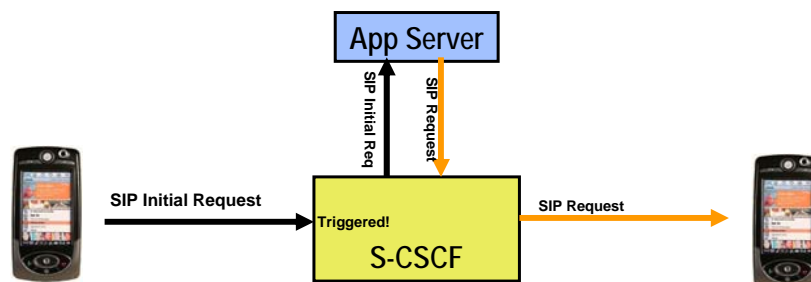

66

## SIP enables different AS Modes of Operation

Four modes of operation are distinguished:

- Application Server acting as terminating UA, or redirect server
- Application Server acting as originating UA
- Application Server acting as a SIP proxy
- Application Server performing third party call control/ B2BUA mode

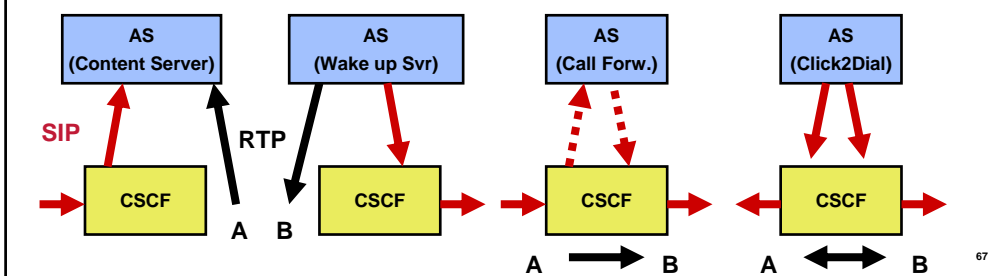

67

## How does a SIP AS Provide Enhanced Services

- S-CSCF determines that a call requires enhanced service processing
  - **Filtering** may be based on calling / called party or other mechanism (defined by filtering criteria) eg. SIP message type, header fields, etc.
- Based on filtering criteria, the S-CSCF determines the address of the Application server and **relays** the call to the AS function. The Application Server receives the call and invokes the appropriate service logic taking one of the following actions:
  - **Redirects** the call to a new destination
  - **Send the call back through the S-CSCF in order to monitor subsequent call events (ie act as a SIP Proxy)**
- The Application Server (based on some other input) can also set-up calls between **other** entities in the network (ie. act as a **B2BUA**)

68

## Major Service Platform Interfaces

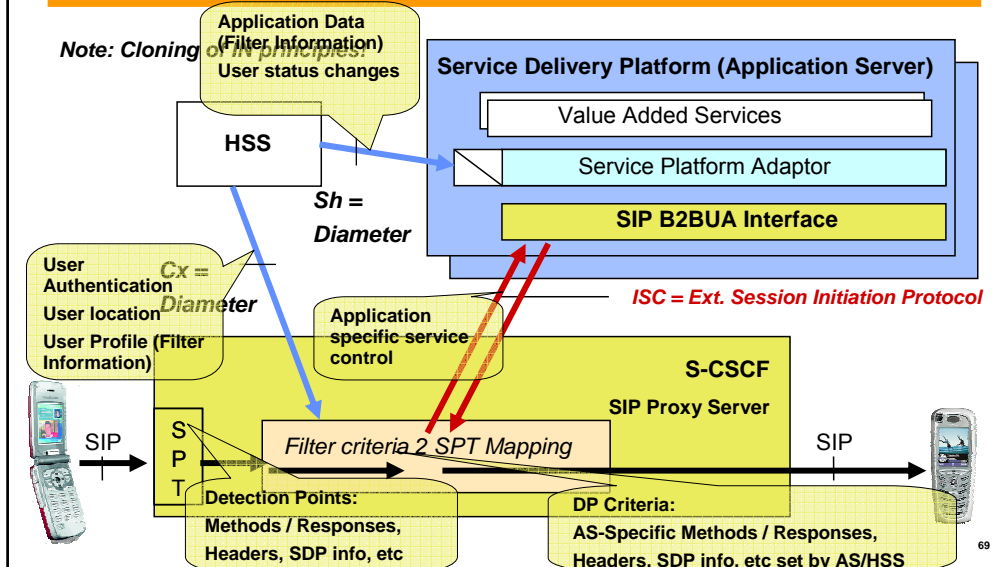

## Cx (and Dx) Interface

- **Cx - Interface supports information transfer between S-CSCF and HSS**
  - Diameter application for user profile handling & user authentication
    - to exchange location information
    - to authorize a user to access the IMS
    - to exchange authentication information
    - to download and handle changes in the user data stored in the server
- **Dx - Interface between I-CSCF and the Subscription Locator Function (SLF) - in case of HSS look-up**
  - Diameter redirect agent functionality to retrieve an HSS address
- **Both RPs are specified in 3GPP TS 29.228 and TS.29.229**
  - TS 29.228 IM Cx and Dx interfaces; Signalling flows and message contents
  - TS 29.229 IM Cx and Dx interfaces based on the Diameter protocol; Protocol details
  - ([http://www.3gpp.org/ftp/Specs/archive/2x\\_series/2x.xxx](http://www.3gpp.org/ftp/Specs/archive/2x_series/2x.xxx))

## **Sh Interface**

---

- **Interface between HSS and Application Server (AS)**
- **Diameter application that allows a Diameter server and a Diameter client:**
  - to download and update transparent and non-transparent user data
  - to request and send notifications on changes on user data
- **Further information on the Sh reference point is provided in**
  - **TS 29.328 IM Sh interface; Signalling flows and message contents**
  - **TS 29.329 IM Sh interface based on the Diameter protocol; Protocol details**

71

## **IMS Filter Criteria**

---

- **IFC Details:**
  - the IFC contents:
    - 1) **Trigger Point**
    - 2) **Service/AS Identifier**
  - **Trigger Point contains one or more Service Triggers linked via the logical expressions (AND, OR, NOT, EQUAL )**
  - **Service Trigger includes:**
    - 1) **Request URI content**
    - 2) **SIP Method, eg. INVITE, REGISTER ...**
    - 3) **SIP Header content**
    - 4) **Session Mode (originating, terminating)**
    - 5) **SDP content**
- **AS Identifier have SIP URI format e.g. sip:As1@as.operator.com**

72

## IMS Initial Filter Criteria

- The IFC is the key point for service provisioning in IMS and specified in 3GPP TS 23.218 and 29.228
- The S-CSCF downloads the IFC's for a particular user from HSS and has the ability to forward SIP messages to an appropriate Application Server (SIP AS, OSA SCS)
- AS application/service invocation is triggered as a result of a pattern matching on any SIP header or body

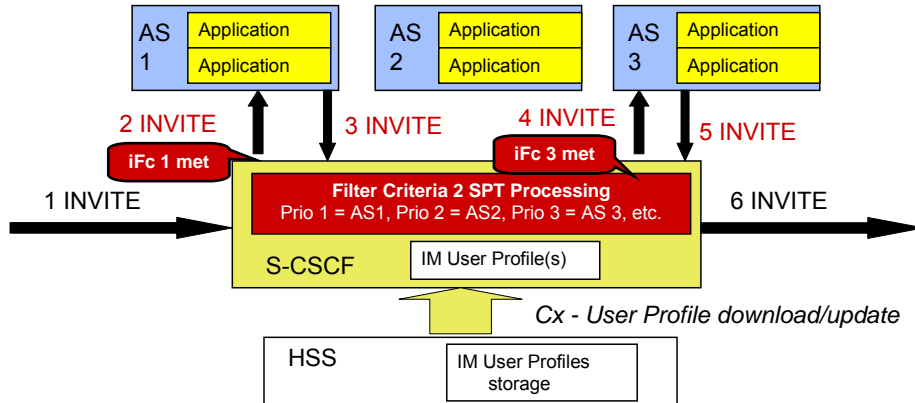

73

## Scalability of the IMS

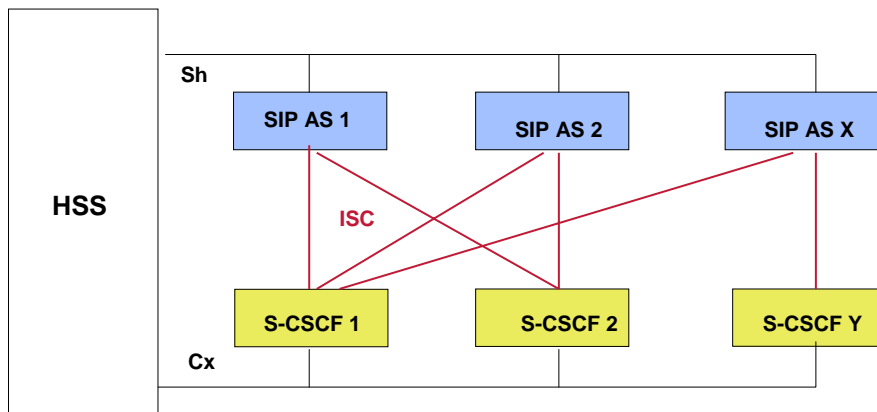

74

## Requirements for an Application Server

- Same as the definition for application servers it is hard to set the boundaries of the requirements for application servers.
- There are “must have” requirements for application servers.
  - Same requirements on scalability, fault tolerance, security and so on as for any other entity in an IMS environment.
  - An Application Server must have at least one Application Programming Interface (ISC).
  - An Application Server must have at least one standard compliant network interface.
- There are “may have” requirements for application servers.
  - Certain applications require multiple standard compliant network interfaces.
  - Certain applications require multiple Application Programming Interfaces.

75

## Network Interfaces and APIs of a SIP AS

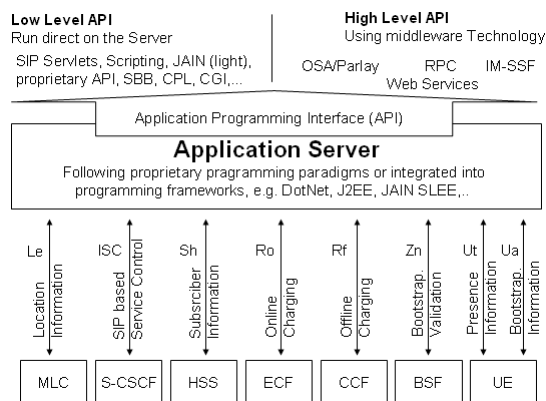

- Within this Part of the tutorial we have a close look into all parts of an application server!

76

## IMS Application Server Options

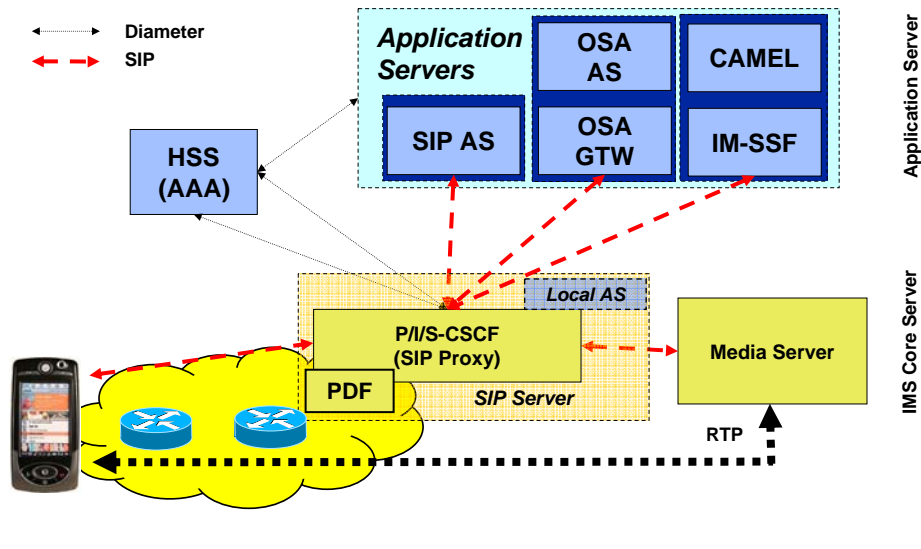

77

## Different AS Alternatives

- **CAMEL Services via Camel Support Environment (CSE):**
  - intended for the support of existing IN Services (provides service continuation).
- **OSA Services via Open Service Access Service Capability Server:**
  - intended for the support of 3rd Party Application Providers. OSA SCS provides access and resource control.
- **IMS services on SIP-Application Server:**
  - intended for new services. A multitude of widely known APIs (CGI, CPL, SIP Servlets) is available.
- **IMS services directly on the CSCF (similar to SIP AS):**
  - SIP-AS co-located on the CSCF
  - seems to be useful for simple services. May be beneficial for the Service Availability and the Service Performance.

78

## CAMEL Reuse within IMS

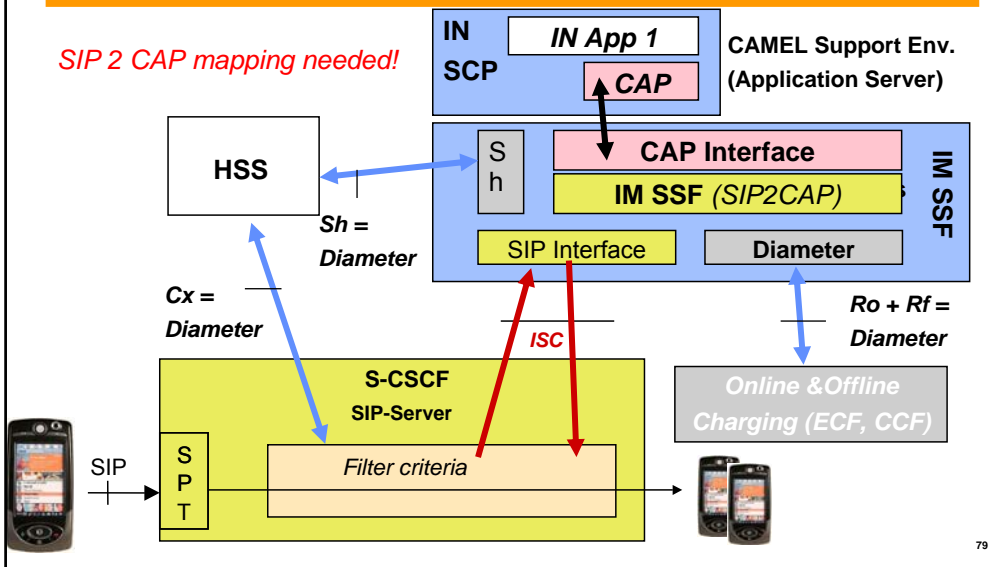

## OSA / Parlay AS within IMS

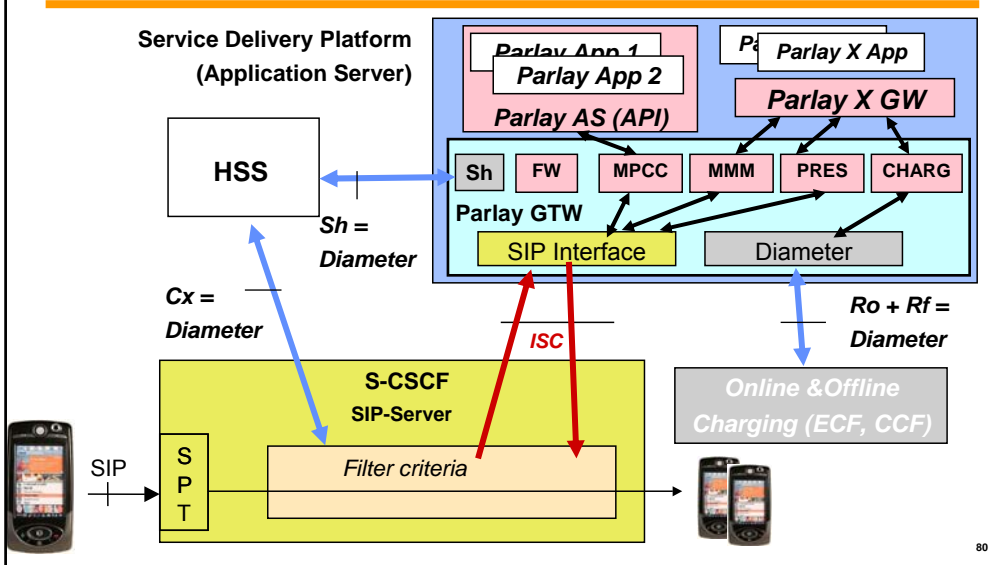



## SIP Application Server (Servlets)

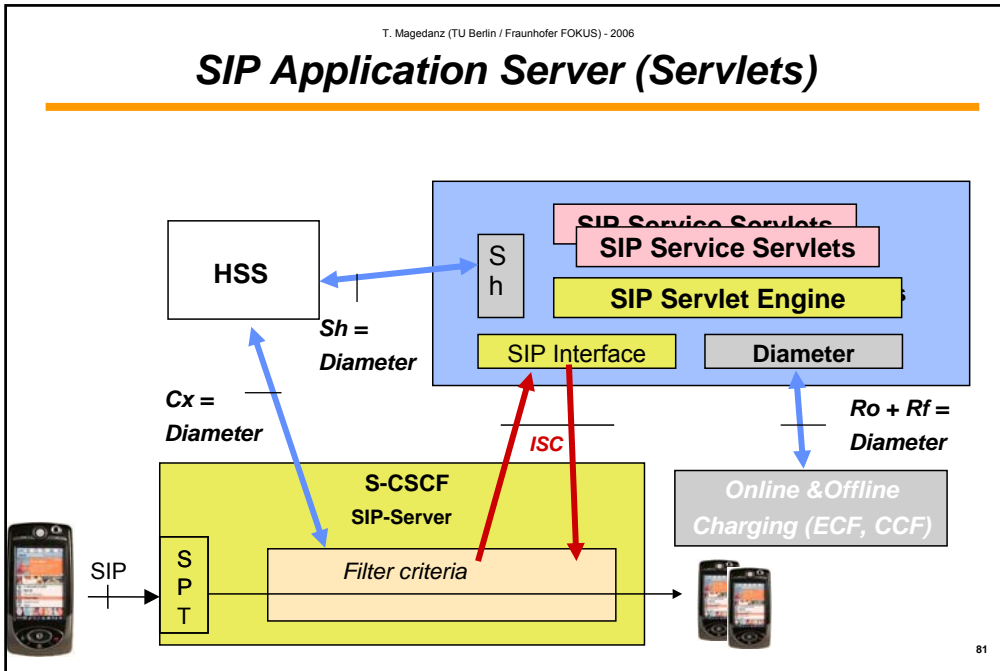

## SIP AS vs. CAMEL vs. OSA/Parlay

- **CAMEL** supports:
  - legacy **IN** services in 2G and 3G networks
  - Services based on **proven** and **reliable IN** technology (reuse!)
  - But CAMEL is expensive and limited in evolution
- **SIP AS** supports:
  - **Multimedia conferencing** services, integrated with HTTP
  - Exploitation of cheaper **internet** technology
  - Easier service creation, but not yet proven for carrier grade services
- **OSA** is an API (!! ) which could be mapped to both CAMEL and SIP
  - **OSA is enabling EAI in Telecoms**
  - Proven technology (reuse of existing services in NGN)
  - Support implementation of different business model (walled vs. open garden)
  - Best support of 3rd parties

## Relating OSA/Parlay vs. CAMEL vs. SIP AS

Seamless NGN Services (opt. by 3rd Parties)

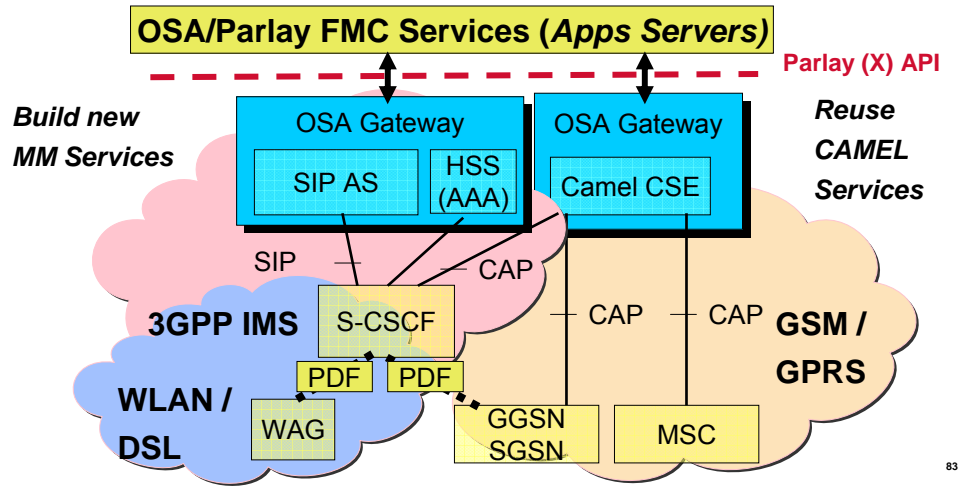

## Overview

- IMS Motivation
- IMS Overview
- IMS Key protocols (IETF SIP and Diameter)
- IMS Key components
- IMS Application Server options
- **Sample IMS Multimedia Applications**
- The IMS Playground @ FOKUS
- Summary
- Q&A and IMS Playground Demos
- References & Acronyms

## IMS integrates different Communication Services

Pre-IMS Communication  
("Service Islands")

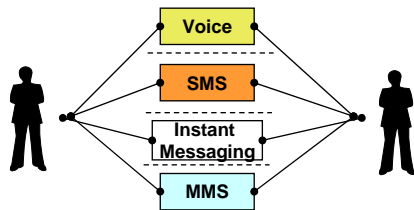

From the usage of specific individual communication services ...

IMS Communication  
("Combinational Services")

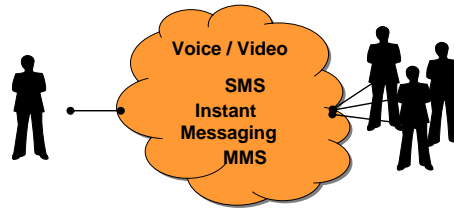

... to the integrated usage of different communication services centered around presence information and within groups (→ communities)

85

## IMS Applications

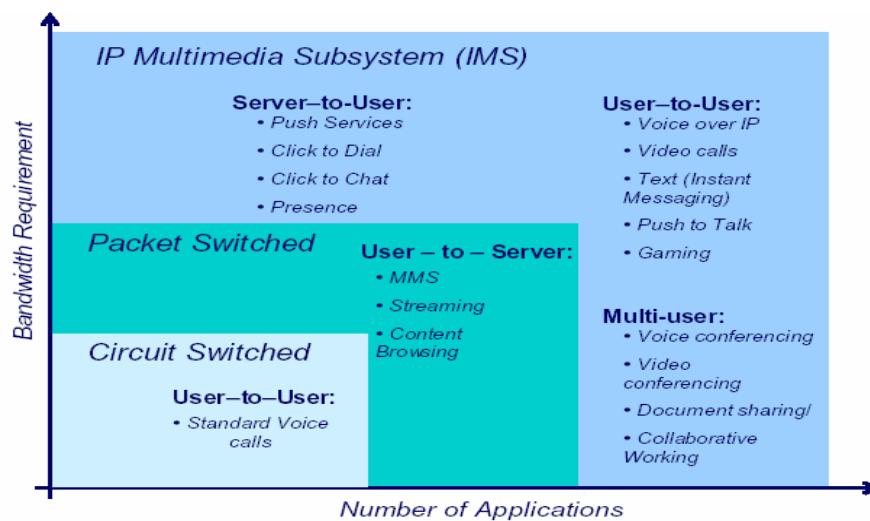

86

## IMS for VoIP Supplementary Services

- Example IMS Service Architecture for an IMS Voice/Video/Data telephony service:
  - the SIP-AS provides Supplementary Services such as e.g. Call-Forwarding, Call-Barring, Simultaneous-Ringing, etc.

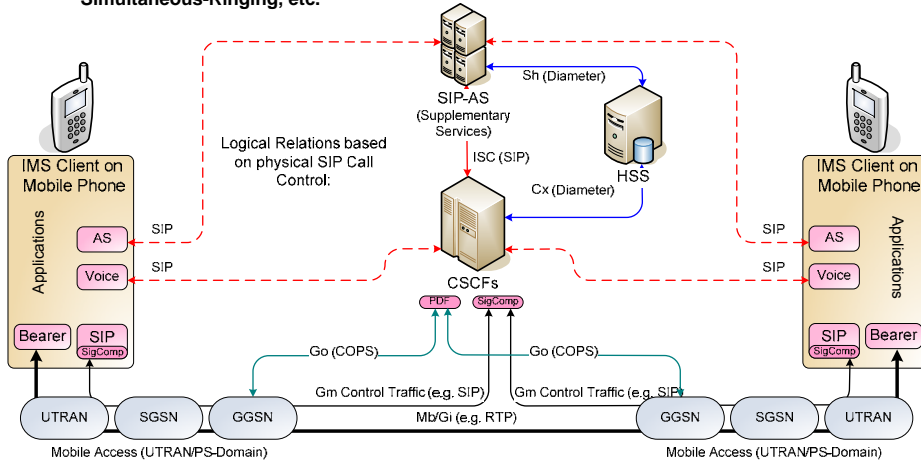

87

## IMS for Presence, Push 2 Talk, IM

- Example IMS Service Architecture for the IMS services:
  - Presence,
  - Push-to-Talk (PTT),
  - Instant Messaging (IM)

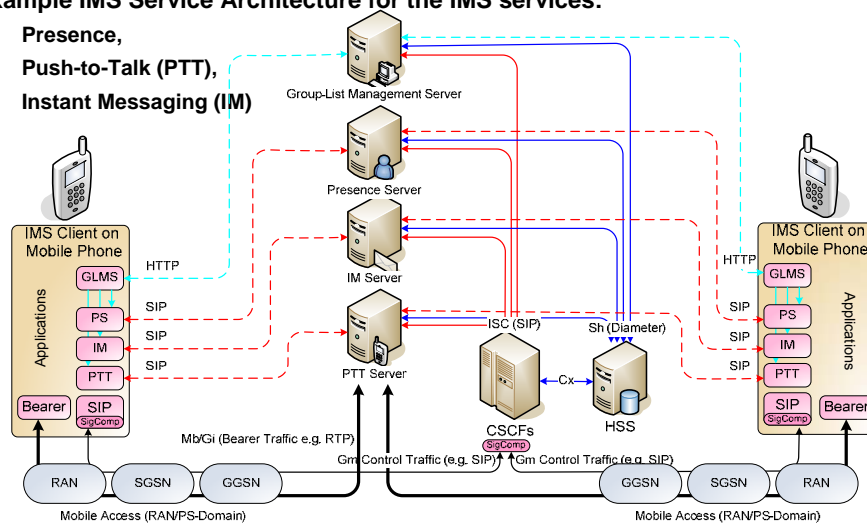

88

## OMA Service Enablers and IMS

- **IMS provides the following:**
  - Routing and reachability
  - Authentication and transitive trust
  - Signaling compression
  - Privacy
  - User profile storage
  - Charging, accounting
  - Interface to the access network
- **OMA SIP-based service enablers are specified on top of IMS as common platform, e.g.**
  - Presence, Group Management, etc.

### Standards



OMA  
for  
Application  
Enablers



3GPP  
for  
Network  
Architecture

89

## OMA Service Enablers and IMS

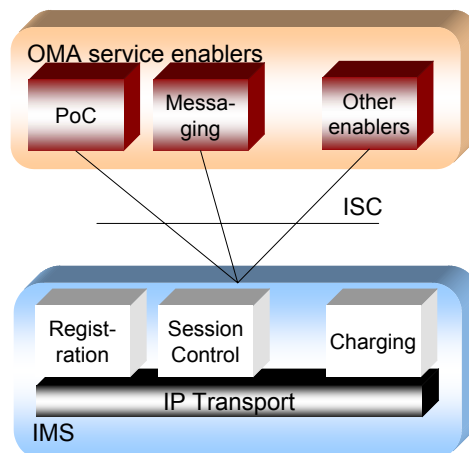

90

## Push to Talk over Cellular (PoC)

- PoC is standardised in the Open Mobile Alliance (OMA), Rel. 1 in 2005
- First specification process was initiated by the MENSA (Motorola, Ericsson, Nokia, Siemens, AT&T Wireless) consortium in 2002, 2003
- PoC is a way of communication that uses half-duplex connections
  - similar to walkie-talkie functionality
  - allows to deliver a talk burst to a collection of users
- PoC client is (usually) in the handset as a soft client
- PoC server has ambiguous functionality: It manages both the signalling and also the media
  - By definition the PoC server is acting as a SIP AS, connecting to IMS CN through the ISC interface
- OMA PoC does not consider access network issues (any access network can be used)
- OMA PoC requires the XML Document Management (XDM) enabler for group session configuration
- OMA PoC may use OMA XDMS architecture for presence as a presence enabler
- Dedicated floor control messages are used to grant access to the floor to ensure semi-duplex paradigm

91

## MENSA PoC Architecture Rel. 1 (2002)

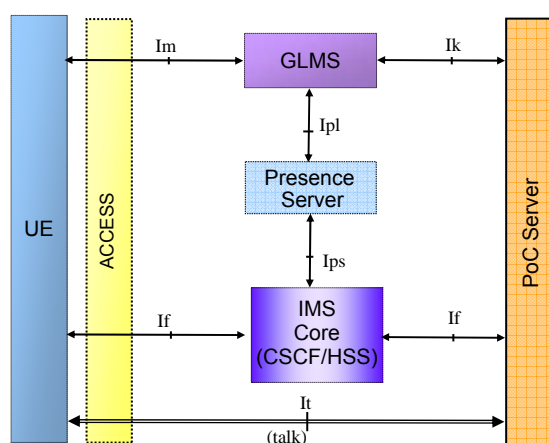

- Introduction of Group List and Management Server
- No presence functionality required
- No Network-Network Interworking (NNI)
- No automated device configuration

Source: PoC MENSA Rel. 1.1

92

## OMA PoC Architecture Rel. 1 (2005)

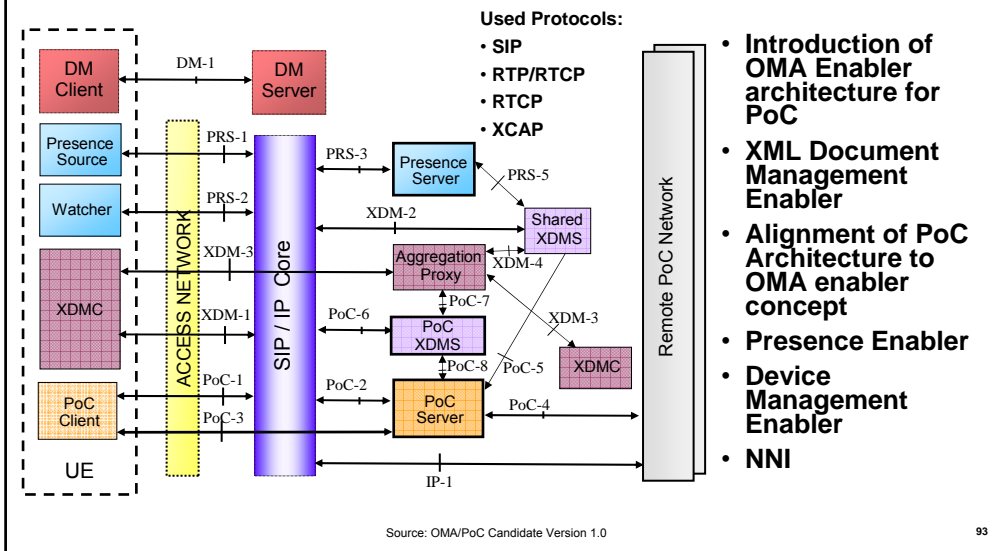

- Introduction of OMA Enabler architecture for PoC
- XML Document Management Enabler
- Alignment of PoC Architecture to OMA enabler concept
- Presence Enabler
- Device Management Enabler
- NNI

## 3GPP2 Multimedia Domain (MMD)

- 3GPP2 MMD is a reference architecture model for cdma2000 family based wireless core network
- Main specifications:
  - “All-IP Core Network Multimedia Domain: Overview”
    - [http://3gpp2.org/Public\\_html/specs/X.S0013-000-0\\_v1.0\\_022604.pdf](http://3gpp2.org/Public_html/specs/X.S0013-000-0_v1.0_022604.pdf)
  - “IP Network Architecture Model for cdma2000 Spread Spectrum Systems”
    - [http://3gpp2.org/Public\\_html/specs/S.R0037-0\\_v3.0\\_111303.pdf](http://3gpp2.org/Public_html/specs/S.R0037-0_v3.0_111303.pdf)
- based on IP protocols, elements and principles
- Main protocols are (IETF’s) SIP, DIAMETER and Mobile IP
- Consists of:
  - Packet Data Subsystem (PDS): supports general packet data service
  - IP Multimedia Subsystem (IMS): provides multimedia session capabilities

## 3GPP2 vs. 3GPP

Feature	3GPP	3GPP2
<b>Mobility management</b>	GPRS tunneling	Mobile IP
<b>IP version</b>	IPv4 and IPv6	IPv6
<b>HSS</b>	Database and AAA	Database only, separated AAA
<b>Speech codec</b>	AMR	EVRC and SMV
<b>P-CSCF discovery</b>	Through PDP context activation and DHCP	No support of PDP context
<b>Si interface</b>	Between HSS and IM-SSF (CAMEL)	Not defined, since there is no CAMEL
<b>Smart card</b>	Defined a UCC (USIM or ISIM)	Configuration and security stored in the IMS terminal or in R-UIM (Removable User Identity Module)
<b>P-CSCF location</b>	P-CSCF and GGSN are in the same network	P-CSCF and PDSN (Packet Data Service Node == GGSN) may be in different network
<b>Anchored GGSN/PDSN</b>	Allocated prior to registration	May change even during a session
<b>Go interface</b>	Defined between PDF & GGSN	Not defined yet
<b>Location information</b>	Through Sh interface	Through a Position Server and Position Determining Entity (PDE)

95

## The NGN Definition

- A new telecommunications network for broadband fixed access
- NGN facilitates convergence of networks and services
- NGN enables different business models across access, core network and service domains
- NGN will be an IP based network
- SIP will be used for call & session control
- 3GPP release 6 IMS will be the base for NGN IP Multimedia Subsystem
- NGN enables any IP access to Operator IMS; from
  - Mobile domain
  - Home domain
  - Enterprise domain
- NGN enables service mobility
- NGN enables interworking towards circuit switched voice
- NGN maintains Service Operator control for IMS signalling & media traffic

96



## NGN Global standards cooperation

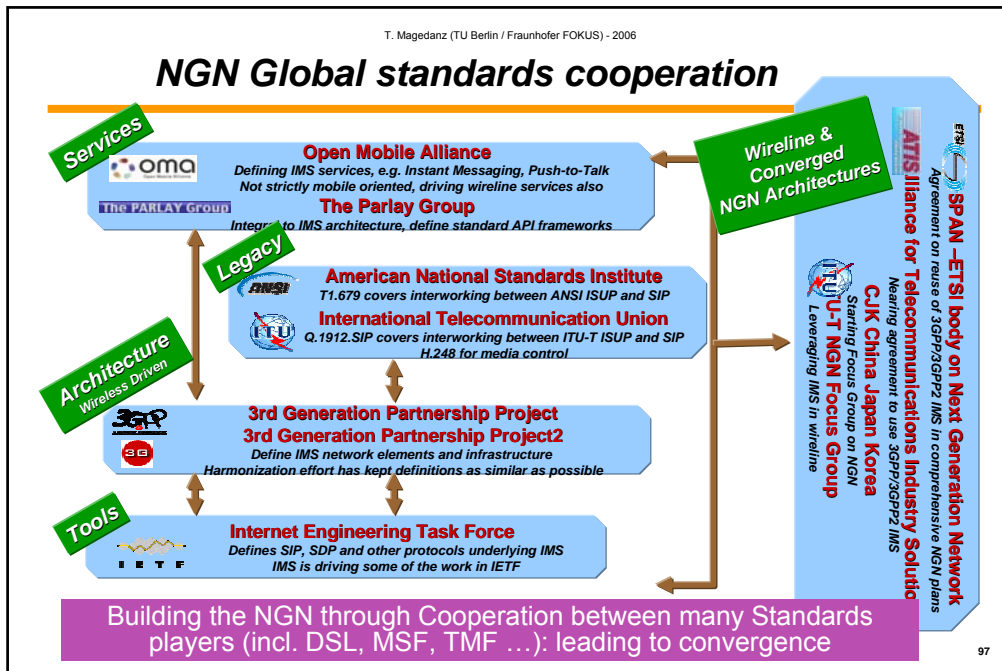

97

## ETSI TISPAN

- The European Telecommunications Standards Institute (ETSI) is an independent, non-profit organization, whose mission is **to produce telecommunications standards** for today and for the future.
- The Next Generation Network will provide:
  - A multi-service, multi-protocol, multi-access, IP based network - secure, reliable and trusted
    - **Multi-services:** delivered by a common QoS enabled core network.
    - **Multi-access:** several access networks; fixed and mobile terminals.
    - **Not one network**, but different networks that interoperate seamlessly
  - An enabler for Service Providers to offer
    - **real-time and non real-time communication services**
    - between **peers** or in a **client-server** configuration.
  - **Nomadcity and Mobility**
    - of both users and devices
    - intra- and inter-Network Domains, eventually between Fixed and Mobile networks

98

## TISPAN NGN Functional Entities

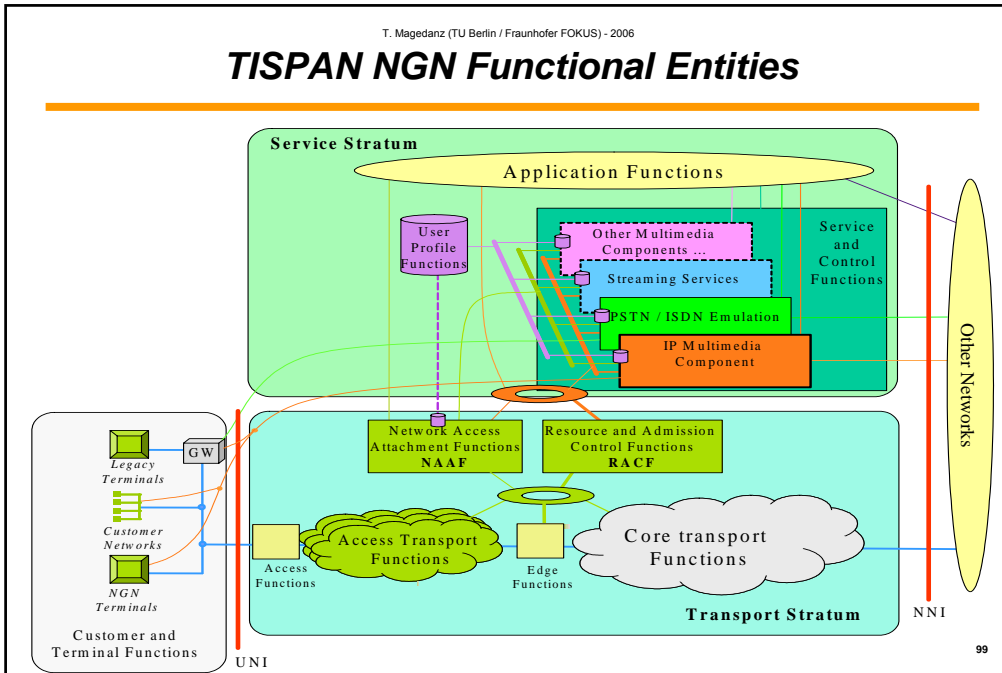

## IMS Architecture in the NGN setting

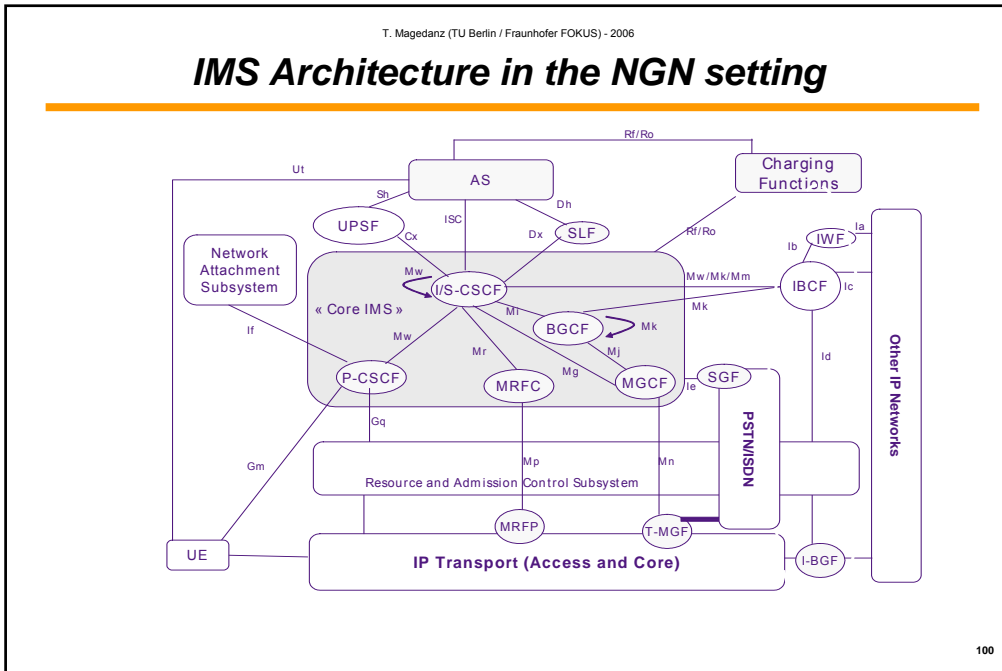

## TISPAN PES - Functional Architecture

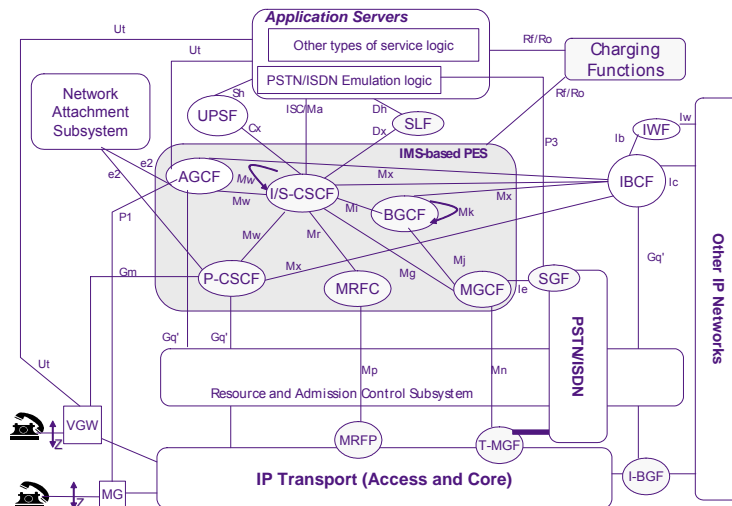

101

## 3GPP R6 and TISPAN R1 NGN: R6 comparison

- Network Attachment System
  - 3GPP: GPRS entities + HLR (PS part)
  - TISPAN: NASS entities
- Resource Admission Control
  - 3GPP: PDF and GGSN
  - TISPAN: RACS entities + RCEF and BGF entities
- MM Session Control
  - 3GPP: IMS (R6)
  - TISPAN (R1) IMS (R6)
- TISPAN Documentation:
  - [http://portal.etsi.org/docbox/tispan/Open/NGN-R1/Stable\\_Drafts/](http://portal.etsi.org/docbox/tispan/Open/NGN-R1/Stable_Drafts/)

102

## Upcoming IMS Release 7

---

- **Emergency calls in PS and IMS**
  - TR 23.867 - Two building blocks: IMS and PS side. IMS side is given priority to meet TISPAN Rel1 schedule. TISPAN inputs and requirements will be taken into account
- **End-to-end QoS**
  - TR 23.802 provides various scenarios and mechanisms to manage and guarantee e2e QoS
- **Policy Control Evolution and Charging**
  - TS 23.803 - Evolution of the Policy Control and IP Flow Based Charging
    - addition of subscription profile to Policy Control
    - Merging of Go and Gx interface
- **Mp (MRFC - MRFP) interface protocol definition**

103

## Overview

---

- **IMS Motivation**
- **IMS Overview**
- **IMS Key protocols (IETF SIP and Diameter)**
- **IMS Key components**
- **IMS Application Server options**
- **Sample IMS Multimedia Applications**
- **The IMS Playground @ FOKUS**
- **Summary**
- **Q&A and IMS Playground Demos**
- *References & Acronyms*

104

## Joseph von Fraunhofer (1787 - 1826)

The person who has given the name is a good example for what we do!



### Scientist

Discovery of "Fraunhofer-Lines" within the sun light spectrum

### Inventor

New processing methods for lense crafting

### Entrepreneur

Director of a glass works factory

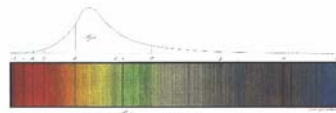

105

## Fraunhofer Society: Profile



58 Institutes

12 750 Employees

1 Billion € Budget

### 7 Alliances

- Microelectronics
- Production
- Information and Communication Technology
- Materials and Components
- Life Sciences
- Surface Technology and Photonics
- Defence and Security

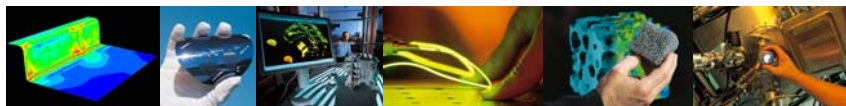

106

## Fraunhofer FOKUS Facts

- FOKUS has been founded 1988 in Berlin, Germany
- 220 employees: scientists, students, technicians originating from 30 nations
- FOKUS is THE Telecoms R&D institute within the Fraunhofer Society
  - Fraunhofer Society is the biggest German R&D organisation, total # of 12.000 employees)
  - 60 institutes in total, 15 institutes in ICT
- FOKUS works since 17 years on convergence of IT, telecoms, internet and home entertainment and performs applied research and development projects
  - Performs strategic studies, solution concepts, system integration and prototyp developments
  - Strong cooperation with universities & Establishment of spin offs (e.g. iptelorg.com)
- FOKUS fundung: 20% state, 80% industry R&D projects
  - Key to success: Strategic Partnerships with big players (DTAG, NTT, etc)
- Main R&D Vision: „I-centric communications“ and „autonomic communications“



107

## NGN Testbed @ Fraunhofer FOKUS

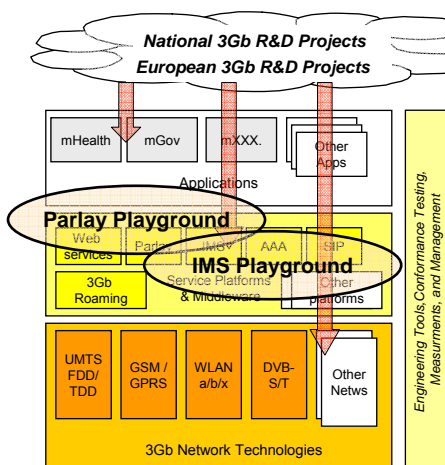

[www.fokus.fraunhofer.de/national\\_host](http://www.fokus.fraunhofer.de/national_host)

### Nat. Open 3Gb Test & Development Center

- Provision of a unique 3Gb Testbed covering all three 3G beyond layers
- Foundation for industrial and academic projects
  - Applications development support
  - Applications validation
  - Service Platform prototyping
  - Infrastructure component testing
  - Network Technologies integration
  - ....
- Officially supported by



108

## IMS playground @ FOKUS

- forms a globally unique state of the art IMS infrastructure featuring all major IMS components and interfaces
- is a key infrastructure of the FOKUS NGN Service Delivery Platform test and development center
- comprises
  - a full IMS based on own developments
  - additional best of breed carrier grade components from partners
- Goals:
  - Provision of an open IMS platform and planned interconnection to Operator IMS test beds
  - Interoperability test of IMS components (S-CSCFs, Media Gateways, SIP AS, etc.)
  - Environment for development of new MM applications, application platform extensions and IMS mobility, QoS and security research
- Contact: [www.fokus.fraunhofer.de/ims](http://www.fokus.fraunhofer.de/ims)

109

## OPEN IMS Playground Overview

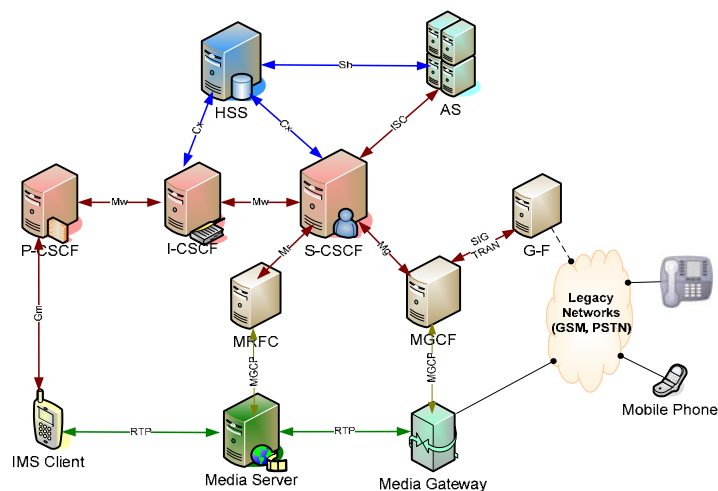

110

## FOKUS – Components in the IMS Playground

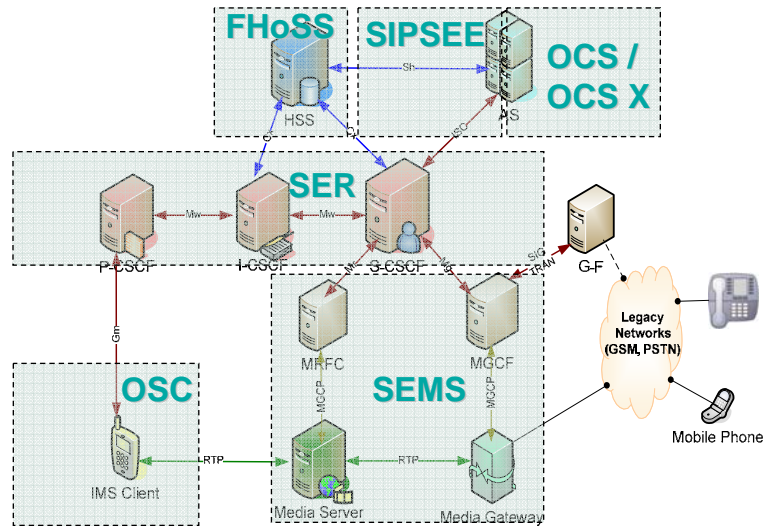

111

## FOKUS – developed IMS Components

- **IMS Core**
  - Call Session Control Functions
    - SIP proxy with 3GPP features - **SER**
  - Home Subscriber Server
    - Diameter based AAA Server- **FHoSS**
  - Media Server
    - Media Streaming – **SEMS**
- **IMS Application Layer**
  - IMS compliant SIP Clients – **OSC**
  - Application Server
    - SIP Servlet AS – **SIPSEE**
    - Parlay X Gateway – **OCS-X**
    - Parlay Gateway – **OCS**

112



## Integration of Partner Components @ FOKUS IMS PG

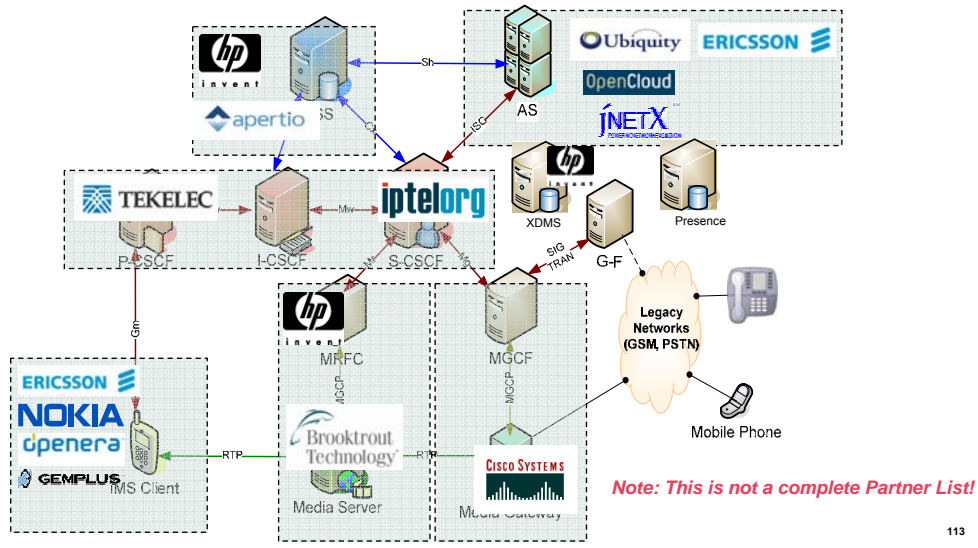

113

## Reference Customers

- Consulting on IMS development strategies for major vendors
- Consulting on bids and gap analysis of commercial products for key global integrator
- Extensions (Interfaces/Reference Points) of commercial solutions of various vendors
- Implementation of prototypes for vendors and operators
- Integration and Compliancy testing of commercial solutions
- Consulting on IMS integration strategies for major German Operator
- Interoperability testing for major European vendors
- IMS Load- /Perfomance testing for key global hardware vendor
- Application Service development for major German operator
- Consulting for establishing IMS Testbeds at remote sites
- Plus German and European R&D projects on Feature Interaction and Service composition

114

## Overview

- IMS Motivation
- IMS Overview
- IMS Key protocols (IETF SIP and Diameter)
- IMS Key components
- IMS Application Server options
- Sample IMS Multimedia Applications
- The IMS Playground @ FOKUS
- **Summary**
- Q&A and IMS Playground Demos
- *References & Acronyms*

115

## Service Layer technology maturity

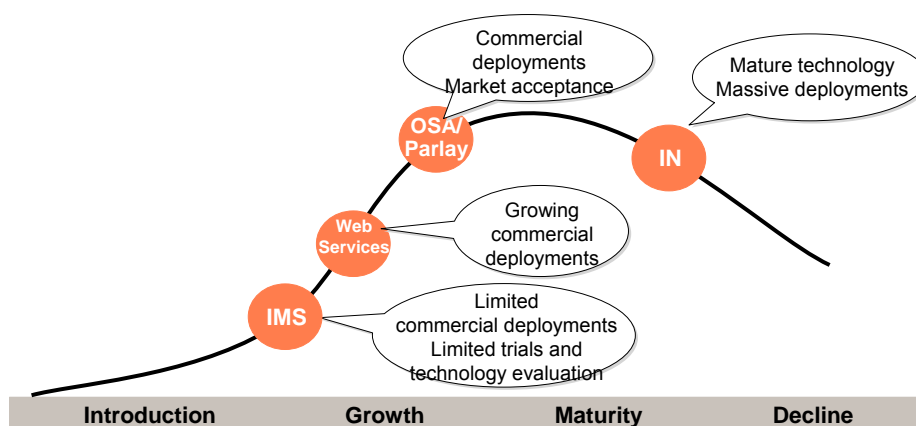

116

## Legacy Services leveraged for Combi. Services

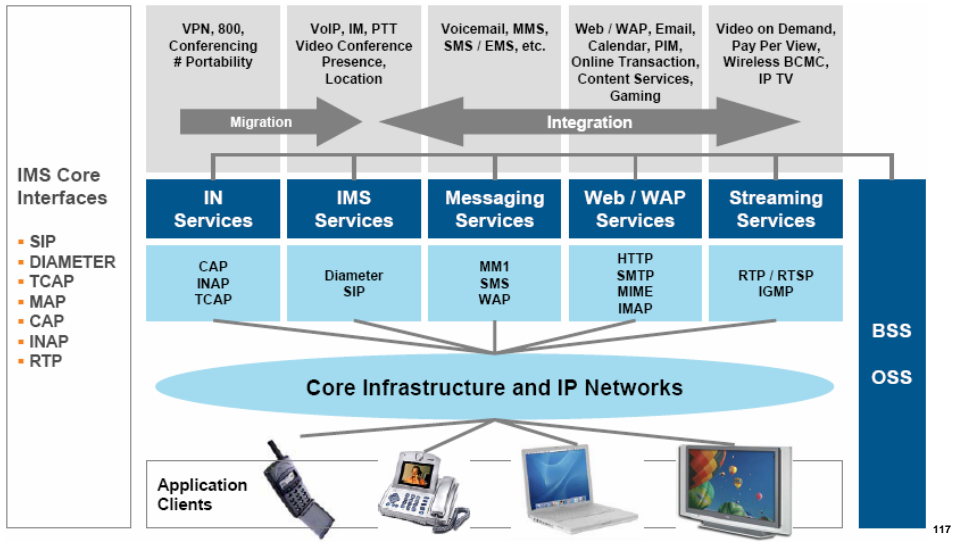

## IMS Introduction Challenges

- IMS Integration Challenges
  - Core Network, SCE&SDP, OSS/BSS, Charging System

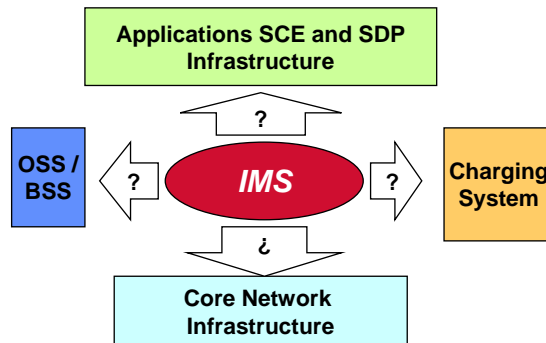

## Single Vendor versus Multiple Vendor Strategie

- **Single Vendor Strategy**
  - **Pros:** Probably faster Integration
  - **Cons:** Vendor lock, potentially limited innovation, no vendor is good in all aspects!
- **Multi Vendor Strategy**
  - **Pros:** Choose best of bread vendors, competition (lower prices), more innovation
  - **Cons:** More complex integration, Whom to blam in case of problems?
- **Realistic Scenario**
  - **IMS Core likely to come from one vendor – assuring basic operation**
  - **Applications layer based on multiple vendors – service innovation & flexibility**

119

## Wireline IMS Introduction

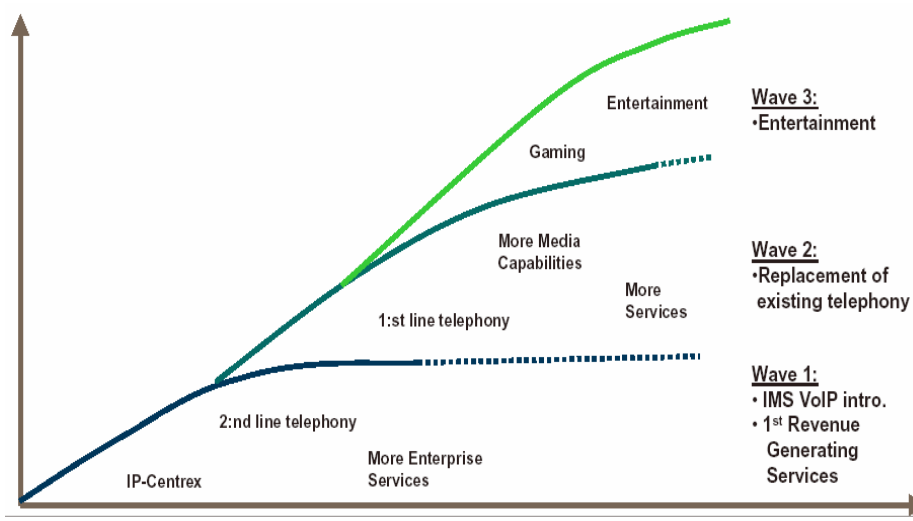

## Wireless IMS Introduction

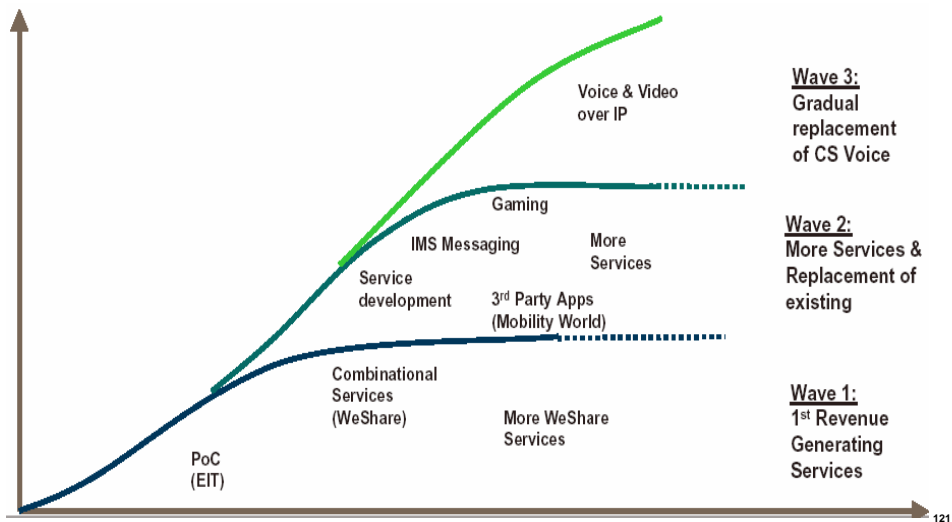

## IMS Deployment Contexts

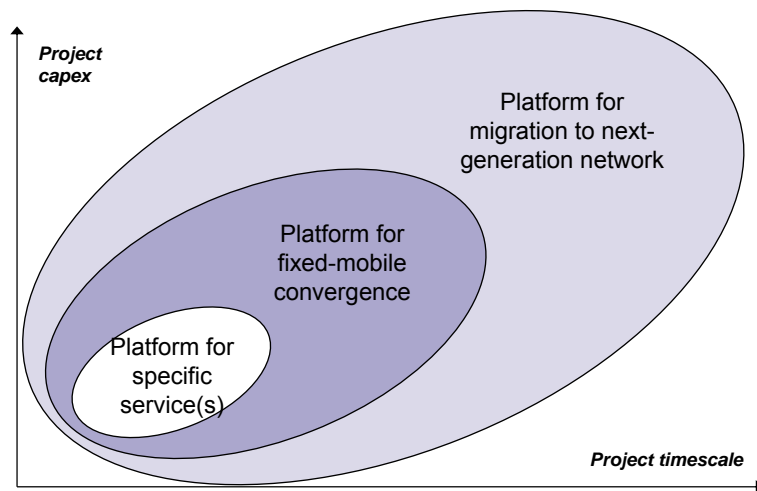

## Ovum's view of the 3 phases of IMS adoption

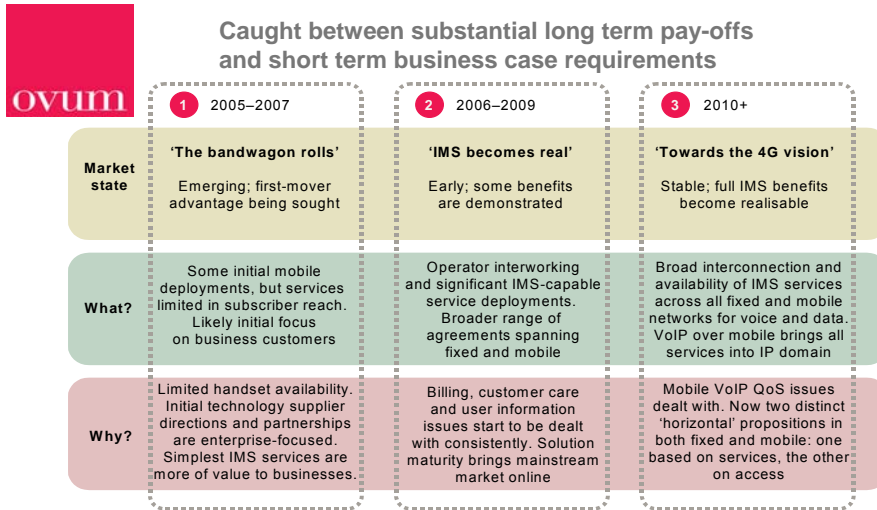

Source: Ovum

123

## IMS Deployment Worldwide

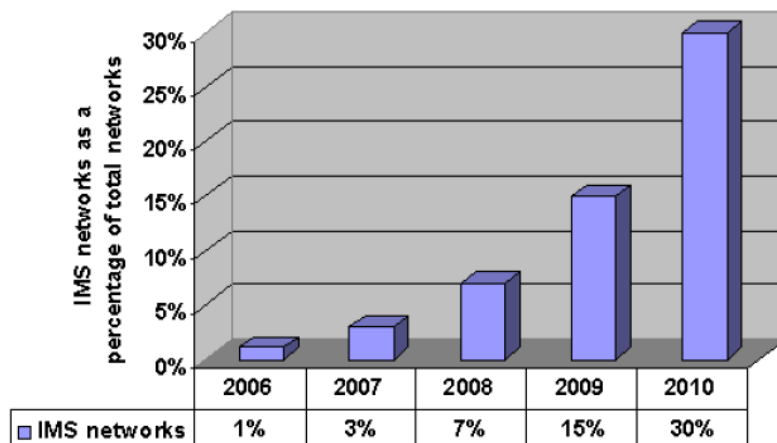

Source: visiongain

124

## NGN Service Platforms

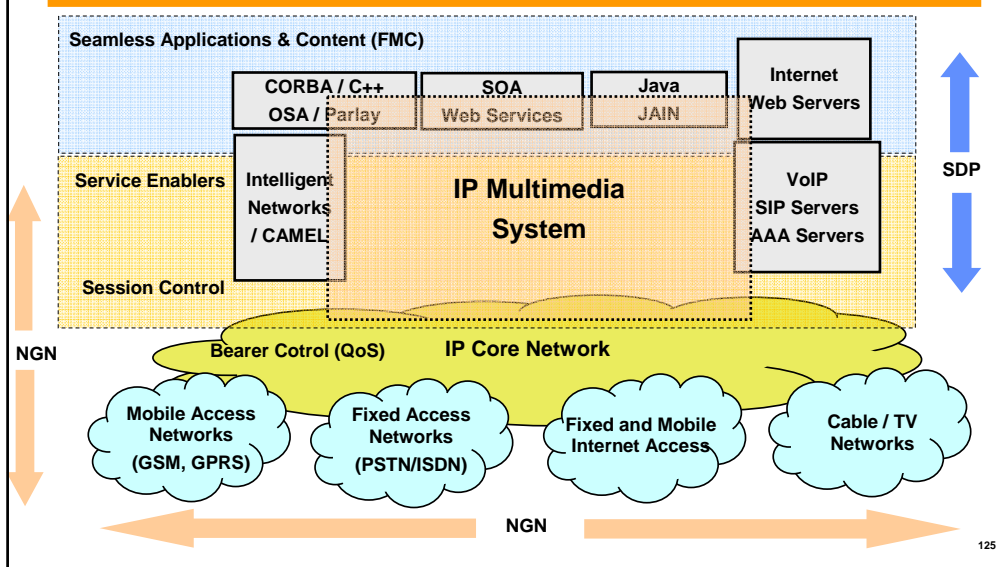

## IMS to „unglue“ the value chain

### GSM value chain

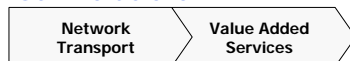

- Tight vertical integration of network and services
- Limited access for 3rd Parties (MVNO, Service Provider)
- Operators struggle to offer attractive service portfolio

### IMS value chain



- Loose vertical integration of networks, services and applications
- Standardized interfaces allow easy integration of partners

- Focus on core competencies and economies of scale
- Enriched service offerings for target communities

## SKYPE - Shows demand for Community Services

- 51 million registered users
- IMS functionality at a fraction of cost
- Client: PC's, WLAN/DECT/BT phones
- Cross Operator community
- On net calls „free“ off net calls pay
- Standardized API's. Lots of apps
- 30% of users are SME's



**However Skype is limited as Group and presence management is limited and integration with Click to Talk, Click to SMS, Location awareness, etc. is missing → This is the operator opportunity!!!**

## From PTT to Community-Support

- PoC/PTT basically defines a specific service based on generic enablers (Presence, GLMS/XDMS, FOTA)
- Infact PoC/PTT could be regarded as a specific instantiation of a group communication framework
- Making money with PoC/PTT is unclear
- Making money with SMS and voice calls is clear
- Idea:
  - Reuse PoC/PTT enablers for other communication services as well
    - Integrated Presence driven IM, email, SMS, MMS, VoIP, CS-Calls, Video calls, etc.
  - Provide group communication to those who really need it
    - well established Communities (Sports, Work, health, fun) will appreciate this!



## ***IMS is a perfect basis for eCommunity services***

- IMS is today considered as the common platform for FMC and NGNs
- A convergent community-service can ideally be based on the IMS platform granting:
  - convergence and compatibility between fixed/mobile networks
  - multi-media and converged services support
  - providing key community service enablers, such as
    - Group Management
    - Presence
    - IM / PoC
    - generic VoIP/MMoIP support, etc.

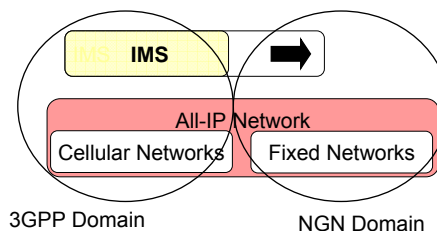

129

## ***Mapping of eCommunity Features to IMS Enablers***

- Support of various end user systems (PC from home, Notebook/Phone on the go) for seamless communications everywhere and any time
- Dynamic group management (open vs. closed groups)
- Presence information of community members
- Location information of community members and navigation support
- Click to communicate functionality (voice calls, video calls, SMS, MMS, email, IM, PoC, etc)
- Common multimedia archives and shared White Boards
- IMS is designed as an overlay to various access networks and also defines Gateways to legacy technologies (CS networks)
- XDMS enabler supports Group management
- Presence enabler supports presence
- Location information can be obtained from dedicated Location servers (Le interface) or from HSS/SIP registrars
- SIP Servlet application server can provide „Click to“ services via HTML service page or dedicated client application in end systems
- IMS „Push to“ functionality e.g. via INFO method

130

## Mapping of eCommunity Features to IMS Enablers (cont.)

- Automated appointment scheduling & logistical support
- Optional profile matching capabilities for bringing people together
- In the future: Virtual reality support
- Communities are third party driven!
- Support of third party services targeted towards specific communities
- Application server integration with corporate databases/outlook
- Application Server and optional HSS interrogation
- IMS supports any media (here interactive dynamic rendered video) and application server control (VR server)
- Usage of OSA/Parlay and later OMA OSE will enable controlled 3rd party services in IMS

131

## Prototyping eCommunities within the FOKUS IMS Playground

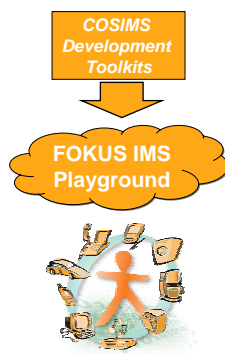

Together with T-Systems, HP and T-Labs eCommunity services are trialed with real life users

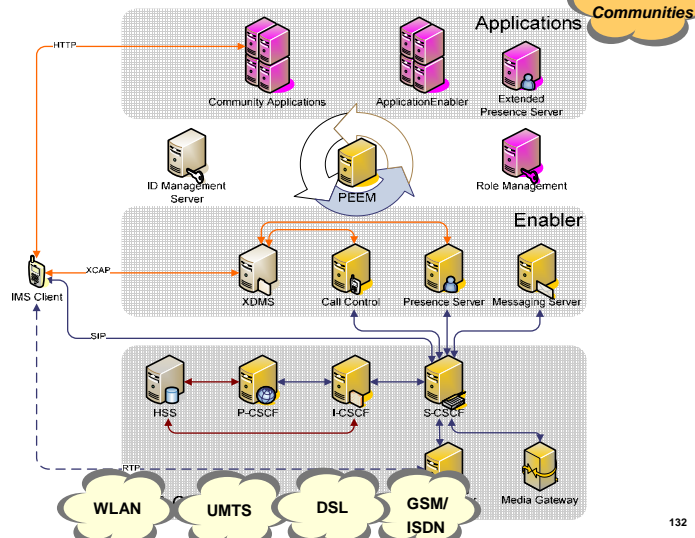

132

## FOKUS NGN R&D Reference Architecture

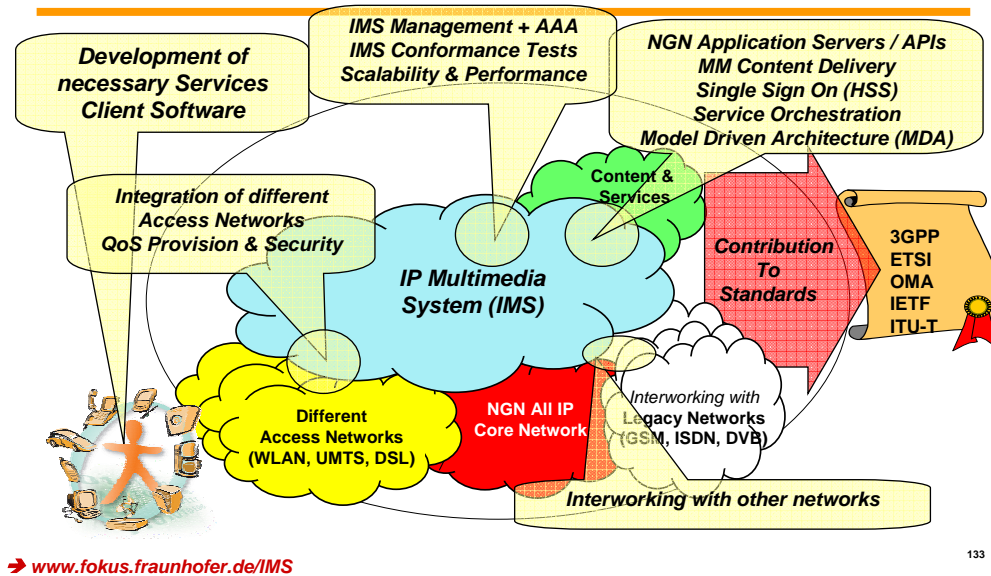

## Summary

- **IMS**
  - is an overlay service network architecture applicable to any IP network (GPRS, UMTS, WLAN, DSL, ..) based on internet standards (IETF)
  - is a global standard (supported by 3GPP, 3GPP2, ETSI, OMA, IETF)
  - can be considered as THE universal Service Delivery Platform for NGNs supporting also Fixed Mobile Convergence (FMC)
- IMS should be mainly considered as a service enabler (i.e. no real IMS services are standardised!)
- Push to Talk / PoC can be regarded as first IMS real life proof of concept
- But biggest service potential is in Community-based services
- FOKUS provides knowhow and a powerful infrastructure for testing IMS components and prototyping IMS / NGN services

## Overview

---

- IMS Motivation
- IMS Overview
- IMS Key protocols (IETF SIP and Diameter)
- IMS Key components
- IMS Application Server options
- Sample IMS Multimedia Applications
- IMS Playground @ FOKUS
- Summary
- Q&A
- References & Acronyms

135



# Any Questions?

136

## Overview

- IMS Motivation
- IMS Overview
- IMS Key protocols (IETF SIP and Diameter)
- IMS Key components
- IMS Application Server options
- Sample IMS Multimedia Applications
- IMS Playground @ FOKUS
- Summary
- Q&A
- References & Acronyms

137

## Recommended IMS Books

Two books on the market describe IMS

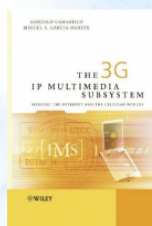

- “The 3G IP Multimedia Subsystem: Merging the Internet and the Cellular Worlds”.
  - Gonzalo Camarillo and Miguel-Angel Garcia-Martin
  - Published by John Wiley and Sons Ltd.
  - ISBN: 0470871563
  - June 2004

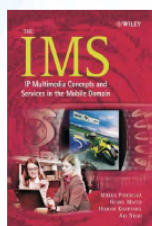

- “The IMS: IP Multimedia Concepts and Services in the Mobile Domain”.
  - Miikka Poikselkä, Georg Mayer, Hisham Khartabil, and Aki Niemi.
  - Published by John Wiley and Sons Ltd.
  - ISBN: 047087113X
  - April 2004

138